



EE-SIM Design and Simulation Environment User Guide

UG5861; Rev 3; 6/21

Abstract

This User Guide contains detailed instructions for using the EE-Sim[®] Design and Simulation Environment. This free online tool suite enables design, simulation, and analysis for a variety of analog and power solutions. The EE-Sim System Power tool provides customized DC-DC recommendations for multi-rail or multi-load systems including processor, SoC, μ C, and FPGA designs. The EE-Sim DC-DC Design tool automatically creates a circuit schematic based on your requirements, saving precious design time and resources. Set up and complete simulations in just minutes. Take advantage of additional features such as sharing designs with colleagues, printing complete reports, and downloading a free version of the EE-Sim OASIS Simulator, which includes node-locked versions of the SIMPLIS[®] and SIMetrix simulation engines.

Table of Contents

1	Getting Started	4
1.1	Introduction	4
1.2	Basic User Prerequisites.....	4
1.3	Conventions Used in This Manual	4
1.4	Register as a New User	5
1.5	Open the EE-Sim Tool Suite.....	5
1.5.1	Start a New EE-Sim Design.....	5
1.5.2	Start EE-Sim as the Recipient of a Shared Design.....	6
1.5.3	Open an Existing Design.....	6
1.5.4	Save Changes to Your Own Design.....	7
1.5.5	Save Changes to a Shared Design.....	7
1.5.6	Close the EE-Sim Tools.....	8
1.6	Web Browsers Support Easy Automatic Logins.....	8
2	Designs, Contacts, and Sharing	9
2.1	My Designs.....	9
2.1.1	Share a Single Design.....	10
2.1.2	Share Multiple Designs.....	10
2.1.3	Manage Your Contacts.....	10
2.2	Use Reference Designs from Maxim.....	11
3	DC-DC Converter Designs	12
3.1	Open an Existing Design.....	12
3.2	Create a New Design	12
3.3	Specify Input, Output, and Other Design Requirements	13
3.4	Create a Schematic and Save Your Design.....	14
3.5	Next Steps	14
3.6	Edit a Schematic.....	15
3.6.1	Edit Component Properties	15
3.6.2	Select a New Vendor Part	16
3.6.3	Annotate a Schematic Using the Toolbar	18
3.6.4	Schematic Toolbar Reference Chart	21
3.6.5	Version History	24
3.7	Simulation and Analysis.....	26
3.7.1	Run a Simulation and Generate Waveforms	26
3.7.2	View Simulation Waveforms.....	28
3.7.3	Customize the Waveform Viewer Output	28
3.8	Compare Design Iterations.....	33
3.9	Generate a Design Report and BOM (DC-DC)	35
3.9.1	Publish a Design Report and BOM.....	35
3.9.2	Download the BOM, Report, and Schematic.....	36
4	System Power Designs.....	37
4.1	Create a New System Power Processor Design	37
4.1.1	Create a New FPGA Processor Design and Schematic.....	37
4.1.2	Create a New Processor/Custom Load Design and Schematic.....	38
4.2	Next Steps	39

4.3	Modifying System Power Schematics.....	39
4.3.1	Add and Connect Product Components	39
4.3.2	Select a Component	40
4.4	Sequencing	43
4.4.1	Add a Sequencer	43
4.4.2	Edit the Group/Rail Assignments and View the Timing Diagrams	43
4.5	Generate a Summary Page and BOM (System Power)	44
4.5.1	Explore the System Power Tool Summary Page.....	44
4.5.2	Generate and Print a Summary Page	45
4.5.3	Generate and Save a BOM	45
5	EE-Sim OASIS Simulator.....	46
5.1	Download EE-Sim OASIS Simulator	46
5.2	Install EE-Sim OASIS Simulator	46
5.3	Start Using the EE-Sim OASIS Simulator for Windows	51
5.4	Download a Schematic	54
6	Design Gallery.....	56
7	Trademarks	57
8	Revision History	58

1 Getting Started

1.1 Introduction

The Maxim EE-Sim[®] tool suite enables registered members of the Maxim Integrated online community to design, simulate, and analyze a variety of analog and power solutions.

Automatically create a circuit schematic based on your requirements in the EE-Sim environment, saving precious design time and resources. Set up and complete simulations in just minutes, and take advantage of the following additional EE-Sim tool features:

- Share designs with colleagues.
- Electronically download, send, or print a complete design report with customized schematics and simulation graphs.
- Download a free version of the EE-Sim OASIS Simulator for more detailed and flexible simulation capabilities.

While using EE-Sim tools, do not forget to explore the other features and benefits of online membership with Maxim Integrated.

1.2 Basic User Prerequisites

This manual assumes you are familiar with basic use of the Windows[®] or MacOS[®] operating systems, user interfaces, and supported web browsers. For example, click, double-click, hold your mouse down, drag, release a mouse, and identifying different mouse pointers or cursor icons and know what they mean. While no claim of ADA or Section 508 compliance is made, because this tool runs in a web browser, additional screen readers and input devices are considered compatible.

1.3 Conventions Used in This Manual

- Items in a list where one or more choices or lists of sub steps that can be performed in *any order* appear with bullets. For example:
 - Option 1
 - Option 2
 - Option 3
- Items in a procedure where each step should be performed in a recommended and often required sequence appear in numbered and lettered lists. Verify that you complete a step before attempting the next step. For example:
 1. Step 1
 2. Step 2
 - a. Sub step 2a
 - b. Sub step 2b
 3. Step 3
- Key areas of screen images appear with callout numbers in circles and are explained in greater detail with matching numbers in a table below the infographic. These infographics often imply a recommended sequence, but they do not represent a series of required steps in a procedure. The screenshots are sometimes modified to demonstrate how the software behaves.
- Items in *italics* represent an emphasis in tone, a special term, or a specific field value to read on screen, select, or enter.

- Items in **bold** represent user interface labels for buttons, fields, messages, tabs, and other items that can be clicked with a mouse or tapped with a supported touchscreen device.
- Items that appear underlined in a **monospace font** represent data values that must be entered exactly as they appear. For example, www.maximintegrated.com or **7.25**.
- This manual uses *click* as a standard term. If using a touchscreen device, you can *tap* links and buttons instead of clicking on them. This manual uses *press* (i.e., press the **Enter key**) as a standard term. Where supported, *enter* values using your choice of input device.
- This manual uses *select* (i.e., select a design to open) as a standard term. Where supported, click, tap, or use a keyboard to select an item.
- This manual uses *choose* (i.e., choose a color) as a standard term. Where supported, click, tap, or use a keyboard to choose an item.

1.4 Register as a New User

As a new user, start here to register and create a MyMaxim account profile and password.

1. Open your web browser and navigate to www.maximintegrated.com.
2. At the top of the page, click **Register**. If your user name appears at the top of the page and you do not see a **Register** button, you are already registered and logged in. Skip the remaining steps in this procedure.
3. If you arrived at the EE-Sim gateway page (www.maximintegrated.com/ee-sim) through a shared design or another web link, and you are a new user, click **Register if you are a new user**.
4. Enter your contact information, e-mail address, and specify a secure password. You must enter a valid e-mail address. Your e-mail address is your user ID.
5. Click **Submit**.
6. Open the desktop application, website, or mobile device you use to access e-mail for the account you used to register.
7. Look for a new e-mail message in your inbox with the subject line **Maxim Member Center Notifier** from the *Maxim Member System*. Open the message and click the activation link.
8. Welcome! You are now a new member of the Maxim Integrated online community.

NOTE: By registering for a web account, you agree to the terms outlined in our Privacy Policy.

1.5 Open the EE-Sim Tool Suite

As a registered user, you can now start using the EE-Sim tools.

1.5.1 Start a New EE-Sim Design

Use this procedure if you are new to Maxim Integrated and using the EE-Sim tools for the first time.

1. In a supported web browser, navigate to www.maximintegrated.com.
2. Start the EE-Sim tool suite using any one of the following options:
 - Click the **Design** menu, click **Design Tools**, then under **EE-Sim** click **Design and Simulation Tools (Online)**.
 - Open a part product folder and click **Design & Development**, then **Design Tools & Simulation**. (If **Design Tools & Simulation** is not shown, the part does not have an EE-Sim, SIMPLIS, or SPICE model.) Click the **Create Design** button.
 - Create a bookmark or favorites link to www.maximintegrated.com/ee_sim.

3. If you did not already register, complete the steps in 1.4 [Register as a New User](#). Return to Step 2 if necessary.
4. As a registered user with Maxim Integrated, click **Login if you are a returning user** and begin using the tools.

NOTE: If your user name appears at the top of the page and you do not see a **Login** option, you are already logged in and can skip the next step.

5. On the **Member Log In** page:
 - a. In the **User Name** field, enter your e-mail address.
 - b. In the **Password** field, enter your password for your Maxim account.
 - c. Click the **Log In** button.
6. On the EE-Sim main page:
 - a. Click the **My Designs** tab to view saved designs and any designs shared with you.
 - b. Click the **Home** tab to create a new design.

1.5.2 Start EE-Sim as the Recipient of a Shared Design

Use the steps below if you receive an invitation by e-mail to open a shared design.

NOTE: If this is the first time you are visiting the Maxim Integrated online member community, navigate to <https://memcenter.maximintegrated.com> and click **Register for Membership**. To register, complete the steps in 1.4 Register as a New User.

1. Open your e-mail application, website, or mobile device app that you use to access e-mail (for example, Microsoft Outlook or Gmail®).
2. Open the e-mail message about the shared design you have been invited to view:
 - a. Examine the subject line and notes at the bottom of the invitation. The owner of the design may have included special instructions for you.
 - b. The name of the design and your permissions appear. For example, you can have *Read/Write* permissions for one design and *Read Only* permissions for another design.
 - c. Click the **Accept this Invitation** link. If you already registered, click the link to the shared design in the sender's e-mail invitation. If not registered, see the note above.
3. If you are logged in, skip ahead to the next step. If you are not logged in automatically, complete the **Member Login** page:
 - a. In the **E-mail Address** field, enter the e-mail address that you used to register with Maxim.
 - b. In the **Password** field, enter your password for your Maxim account.
 - c. Click the **Log In** button.
4. Once in the EE-Sim tool:
 - a. Click the **My Designs** tab to view the shared design and any additional designs that you save or receive through sharing.
 - b. Click a design to open it.

1.5.3 Open an Existing Design

Use this procedure to open and resume work on a saved design or open a shared design.

1. Open a web browser and navigate to www.maximintegrated.com/ee_sim.
2. If you are logged in, click **Start the EE-Sim tool** and skip the next step.
3. If you are not logged in automatically, click **Login if you are a returning user** and complete the **Member Login** page:

- a. In the **E-mail Address** field, enter the e-mail address used during registration.
 - b. In the **Password** field, enter the password for your Maxim account.
 - c. Click the **Log Me In** button.
4. Click the **My Designs** tab.
5. On the **My Designs** page, click the **Name** link or position your mouse over a design and click the **Open** button.
6. If the message, “**Starting a new design overwrites any changes in your current design**” appears, click **Start New Design**. (The currently opened design will not be saved. See next section to save a design.)
7. Your design opens at the last saved page in the design process.

1.5.4 Save Changes to Your Own Design

1. Make any changes to the design.
2. Click the **Save** button to save your design. To save changes keeping the same design name, click **Save** again in the **Save Your Design** window.
3. To save your design changes as a new design, continue with the remaining sub-steps:
 - a. In the **Design Name** field, enter a unique new name to differentiate this design from your other designs as well as the shared designs of other users. For example, save the *MAXIM 17598 MyDesign1* design as *MAXIM 17598 MyDesign2*.
 - b. In the **Design Description** field, enter a short description of the modified design for you and any recipients if you later decide to share the design.
 - c. Click **Save**.

1.5.5 Save Changes to a Shared Design

A shared design can always be saved as a new design by saving it using a new name. Someone with Read/Write access can also save a shared design using its original name, overwriting the original design.

1. Click the **My Designs** tab.
2. On the **My Designs** page, click the **Name** link or position your mouse over a design and click the **Open** button to open the design.
3. If another design is already open, the following message appears:
Starting a new design overwrites any changes in your current design.
4. Click **Start New Design** to open the design. (The currently opened design will not be saved.)
5. Make any changes to the design.
6. Click the **Save** button to save your design.
 - a. If you have Read-Only access to the shared design or simply want to save your shared design changes as a new personal design that is not shared, continue with the remaining sub-steps:
 - i. In the **Design Name** field, enter a unique new name to differentiate this design from your other designs as well as the shared designs of other users. For example, save the *MAXIM 17598 MyDesign-001* design as *MAXIM 17598 MyDesign-002*.
 - ii. In the **Design Description** field, enter a short description of the modified design for you and any recipients if you decide to share the design.
 - iii. Click **Save**.
 - b. If you have Read/Write permission, you can overwrite the original design. Updates are applied to the design and it maintains the same name. The person who shared this design can also view these changes.
 - iv. In the **Save Your Design** window, do not change the design name.
 - v. Click **Save**.

1.5.6 Close the EE-Sim Tools

The EE-Sim tool suite is designed for ease-of-use. After logging in, you can end your session at any time and resume work again without being forced to logout or log back in again.

Follow these steps to end the session.

1. Click the **Save** button to save any changes made to your design.
2. Close your browser.

NOTE: The next time you start the EE-Sim tools, you are logged in automatically unless you manually or automatically clear cookies from your browser, or are logged out of the Maxim website. If you delete your cookies or log out of the Maxim website, log in to the Maxim website again to confirm your identity before using the EE-Sim tools.

If you wish to end your session and remove your EE-Sim cookie, click the **Close EE-Sim** link at the bottom of any page. (Note this will not log you out of the Maxim website.)

1.6 Web Browsers Support Easy Automatic Logins

When you log in to the Maxim Integrated website, you can rely on standard security protocols to keep you logged in as a convenience. If you return to the site and are not automatically logged back in, you must manually enter your login credentials again. Common reasons for a login request include:

- You cleared browser cookies after the last successful login. Cookie settings might be cleared on a shared workstation by a network security policy, or cleared from your own PC as a personal preference, or by an anti-virus program.
- You are browsing in the web browser's private or incognito mode.
- You are using a different browser, computer, or device from the one used to login last time.

2 Designs, Contacts, and Sharing

2.1 My Designs

There is no particular procedure to follow when it comes to managing designs. As you create and share them, your design list grows. Refer to the following image to get started.

The screenshot shows the EE-Sim My Designs interface. At the top, there are tabs for 'New', 'My Designs', 'Maxim Designs', and 'Download'. A 'Return to Current Design' button is highlighted with a circled '1'. Below the tabs, a message says 'These are your saved designs. Hover to see info.' A table of designs is shown with columns for Name, Date, Status, and Type. The table is sorted by Date in descending order, indicated by a downward arrow in the Date header (circled '2'). The table contains several rows of design entries. A design entry is highlighted with a circled '3', and a detailed view of that design is shown on the right. The detailed view includes the design name, description, date, status, and type, along with 'Open', 'Share', and 'Delete' buttons (circled '4'). At the bottom of the table, there are navigation links: 'Showing 1 - 10 of 21', 'First', 'Previous', '1', '2', '3', 'Next', and 'Last' (circled '5').

Name	Date	Status	Type
George N. Jinere Great new design for customers in new s...	10/25/2013 4:48 PM	Owner	DC-DC
ED-MAX-16907/09 DRAFT-001 DC-DC design description..	10/25/2013 4:45 PM	Owner	DC-DC
20131025-MAX-17597-DESIGN-1 Government customer interested in our p...	10/25/2013 4:43 PM	Owner	DC-DC
MAXIM 17598 20131019-002 Version 2: A new approved design with a...	10/25/2013 4:26 PM	Owner	DC-DC
MAXIM 17598 20131019-001 A new approved design with approved pa...	10/25/2013 4:25 PM	Owner	DC-DC
Design 20131024-001 Description.	10/24/2013 4:01 PM	Owner	DC-DC
System Power Design 004 System Power design for 12-rail process...	10/19/2013 9:24 AM	Owner	System-Power
New Design 03 A new design for project P2 for 2015 Q1.	10/19/2013 9:15 AM	Read Only	DC-DC
My Original Design 001 Original shared design from my colleague.	10/19/2013 6:10 AM	Owner	DC-DC
2014 MyDesign 002 A second design based on the MAX 175...	10/19/2013 6:09 AM	Owner	DC-DC

- 1 My Designs:** Click the **My Designs** tab to view, manage, sort, open, share, and delete designs. If you navigate to the **My Designs** page from an open design, a **Return to Current Design** button appears to take you back to the last page you were viewing to continue working on the open design. A button can also appear for the last EE-Sim design tool open. Possible button names include **Return to DC-DC Tool**, **Return to System Power Tool**, **Return to PLL Tool**, or **Return to Filter Tool**.
- 2 Header Labels Show the Sort Order:** Click a column header to toggle the ascending or descending sort order for each column. In this example, the entire table of designs is sorted by date in descending order and is indicated by the arrow pointing down in the **Date** column header.
- 3 Open a Design:** Click the design name hyperlink to open a design. The value in the **Status** field indicates your permission level for that design including *Read Only*, *Read/Write*, or *Owner*.
- 4 Sharing:** Position your mouse over a row in the designs table to view its full description, shared contacts, and permissions. Available buttons include **Open**, **Share**, and **Delete**. In the top example, the owner of a DC-DC design has not shared it with anyone. In the bottom example, a contact person has been granted Read-Only permission to a System-Power design.
- 5 Navigation:** Use the convenient links at the bottom of the list to navigate through multiple pages with up to ten designs appearing on each page.

2.1.1 Share a Single Design

Use this procedure to share a specific design with a contact. Select the design to be shared.

1. Option 1. On the **My Designs** page, position your mouse over the design you want to share. In the dynamic status area that appears on the right side, click **Share**.
 - a. In the **Manage Permissions** window for the selected design, select *Read/Write*, *Read Only*, or *No Access* for each contact in the list. (This option enables you to share the design with multiple contacts.)
 - b. (Optional) Click **Apply** to save your settings.
 - c. Click **Preview and Send Invitation**.
2. Option 2. Open a design and click the **Share** button in the upper right corner of the Schematic page.
 - a. In the **Share Your Design** window, in the **Share With** field, select a contact or click **Add Contact** to enter a new contact.
 - b. In the **Set Permissions Level** field, choose *Read Only* or *Read/Write*.

NOTE: For both options, continue with the following common steps.

3. In the **Subject** field, enter a short title for the e-mail message to the new or existing contact.
4. In the **Message** section, ensure your name is shown as the person sharing a design. Add notes in the **Additional comments** field at the bottom of the invitation.
5. Review the invitation and click **Send Invite**.

2.1.2 Share Multiple Designs

Use this procedure to share multiple designs at the same time with a single contact.

1. On the **My Designs** page, click **Go to My Contacts**.
2. On the **My Contacts** page, locate a specific contact in the list and click the **Manage** button.
3. In the **Share Multiple Designs** window:
 - a. Select *Read/Write* or *Read Only* for each design in the list. Select *No Access* to disable sharing of that design.
 - b. (Optional) Click **Apply** to save your settings.
 - c. Click **Preview and Send Invitation**.
4. In the **Subject** field, enter a short title for the e-mail message to your contact.
5. In the **Message** section, ensure your name is shown as the person sharing a design. Add notes in the **Additional comments** field at the bottom of the invitation.
6. Review the invitation and click **Send Invite**.

2.1.3 Manage Your Contacts

Use the My Contacts page to help you organize your contacts, send e-mail invitations, and set sharing permissions for collaboration in viewing, approving, or developing new designs.

1. Click the **My Designs** tab.
2. Click the **Go to My Contacts** button.
3. In the **My Contacts** section:
 - a. Click a column header to sort contacts by their e-mail account or by the number of designs shared with *Read/Write* or *Read Only* permissions.
 - b. Position your mouse over a contact to view the names of any shared designs.
 - c. Click **First** or **Last** to jump to the first or last page in the list.
 - d. Click **Previous** or **Next** to go back or advance one page at a time.

- e. Click a page number to view that page of ten contacts. The current page is shown with a border around its number.
4. Click **Manage** to set the design sharing permissions that you want to grant to this contact, if any. In the resulting **Share multiple designs...** window:
 - a. Click a column header to sort the list by design name or permitted level of access.
 - b. Click **Apply** to save any new permissions.
 - c. Click **Preview and Send Invitation** to notify your contact with a personalized message about the design sharing changes you just made.
5. New contacts are added to the **Pending Contacts** section when their e-mail address is not recognized as an existing EE-Sim user. In the **Pending Contacts** section, perform any of the following actions:
 - a. Click a column header to sort contacts by their e-mail account, invitation date, shared designs, or sharing action.
 - b. Click **First** or **Last** to jump to the first or last page in the list.
 - c. Click **Previous** or **Next** to go back or advance one page at a time.
 - d. Click a page number to view that page of ten contacts. The current page is shown with a border around its number.
 - e. Click **Resend Invite** to adjust any design sharing permissions, edit your personalized invitation, and e-mail it to the pending contact again.
6. Click **Go to My Designs** when finished to return to your list of designs.

2.2 Use Reference Designs from Maxim

Maxim Designs are a set of reference circuit designs built and tested by the experts at Maxim Integrated. Use a reference design to accelerate your productivity. Save time by basing your new schematic on a proven existing design. Many of these designs are also available for purchase as evaluation boards.

Follow these steps to create a new design based on an existing reference design:

1. Open your web browser and navigate to www.maximintegrated.com/ee_sim.
2. Click **Start the EE-Sim tool**. If you were not automatically logged in, click **Login if you are a returning user**.
3. Click the **Browse Designs** button. The **Select Design** dialog box is displayed. A list of sample designs appears by name, type, and part number. Click a column name in the heading row to sort the list. The following additional details appear:
 - **Vin-min**: The minimum input voltage.
 - **Vin-max**: The maximum input voltage.
 - **Vout**: The output voltage.
 - **Iout**: The output current.
 - **# Outputs**: The number of outputs in the design.
4. Click anywhere in the row of the reference design you want to open.

NOTE: The original reference design cannot be changed. You are opening a copy of the design, similar to a template.

5. Adjust the schematic only as required. Remember, when working with a valid reference design, making too many edits can defeat the very purpose behind building new designs based on a reference design.
6. Click **Save**.

3 DC-DC Converter Designs

As a registered member of the Maxim Integrated online community, use the Maxim EE-Sim DC-DC Converter tool to design, modify, simulate, analyze, and purchase a variety of power solutions, including step-up, step-down, and isolated configurations.

This tool automatically creates a circuit schematic and bill of materials (BOM) based on your requirements, saving precious design time and resources. Set up and complete simulations in just minutes without having to learn the complexities of the simulator. Take advantage of the following additional features:

- Share designs with colleagues.
- Print a complete report with annotated schematics and custom simulation graphs.
- Download a free version of the EE-Sim OASIS Simulator for more detailed and flexible simulation capabilities.
- Download a copy of your design from the DC-DC converter tool for use with EE-Sim OASIS.

3.1 Open an Existing Design

Open one of your existing designs or a pre-designed template from Maxim.

1. Click the **My Designs** tab to open a saved design.
2. Click the **Browse Designs** button to open one of the pre-designed schematics available from the engineers at Maxim. These designs represent circuits designed, built, and tested in a laboratory environment.
3. You may be prompted by the message below:

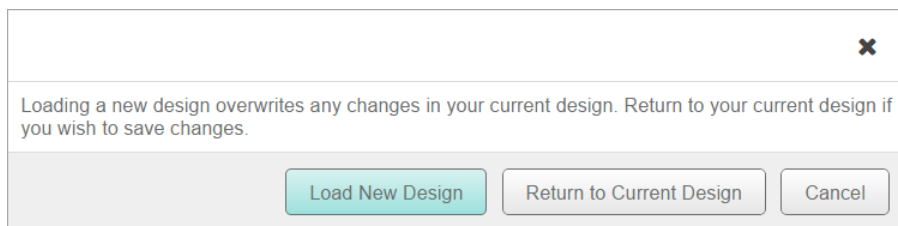

- a. Click Cancel to ignore your last selection and return to the previous page.
- b. Click Return to Current Design to see where you were last working. If the design is valid, keep working on it, click Save, and name that design. If the design was not worth saving, simply load the new design.
- c. Click Load New Design to discard the previous current design and start a new one.

NOTE: You may not be aware that you have another design open, known as the *current design*. The current design is simply the last design you were working on and the tool remembers it so you can go back to it with ease. When in doubt, click **Return to Current Design** to check on your work and save it to keep it. If the current design does not need to be saved, click **Load New Design** with confidence.

3.2 Create a New Design

Use the EE-Sim environment to create an unlimited number of new designs. After entering your detailed input requirements, generate an interactive schematic with components you can modify.

1. Open a web browser and navigate to www.maximintegrated.com/ee_sim.
2. Click **Start the EE-Sim tool** or **Login if you are a returning user**.
3. If you are logged in, skip ahead to the next step. If you are not logged in automatically, complete the **Member Login** page:

- a. In the **E-mail Address** field, enter the e-mail address that you used when you registered.
 - b. In the **Password** field, enter your password for your Maxim account.
 - c. Click the **Log Me In** button.
4. On the **Home** tab, click the **Enter Part Number** button.
5. (Optional) Begin typing a valid part number into the Part Number entry box. A list of available part numbers will be displayed. Click on the desired part number from the list.
6. (Optional) Instead of browsing all available part numbers, use the DC-DC Converter Selector to select a part based on your criteria:
 - a. Enter an input voltage range and specify up to two outputs. Click **Search**.
 - b. Select the converter type and features you need.
 - c. Search, sort, and browse the list of matching converters in the **Choose Converter** section.
 - d. Click a part number to create a new design based on that part.
7. The **Design Requirements** page appears. Your selected part number is displayed in the upper left corner.
For example:

Part Number: MAX17598 

Design Name: Save Design
8. (Optional) To view a PDF datasheet, click the PDF document icon for the part.
9. Continue to the next topic to specify your design requirements.

3.3 Specify Input, Output, and Other Design Requirements

All design requirements are set to default values when a new design is opened. Use this procedure to edit those values before generating a new schematic.

1. On the **Design Requirements** page:
 - a. In the **Input Requirements** section, enter your input values in each field.
 - b. In the **Output Requirements** section, enter your output values in each field.
 - c. In the **Design Priorities** section, specify the cost and performance considerations that you want to emphasize in the **Performance Tradeoff** and **Cost Tradeoff** fields. Choose to optimize your design for efficiency or small size, or even to balance the design between both factors. For cost trade-offs decide between higher performance and lower cost.
 - d. In the **Design Criteria** section, enter your settings in each field.
2. If available, click **Show Advanced** to view additional requirements. Click **Hide Advanced** to hide the additional requirements and simplify the current page.

NOTE: The sections and fields that appear can vary by part. Also be aware that hidden advanced requirements are still used in the design even though you can choose not to show them in your current browser window.

3. Apply any of the following tips to save time and improve accuracy:
 - a. Press the **Tab** key to move to the next field.
 - b. Verify that the values entered are in the correct field and in the required units.
 - c. Position the mouse pointer over a field to see a tooltip. For example, the tip might show the acceptable minimum and maximum values for a specific field.
 - d. In fields that require a limited set of acceptable values, enter a value using any of the following methods:
 - Click the  drop-down menu icon and choose a value.
 - Enter the first digit of the closest matching value.

- Press the **Tab** key to enter the field, then press the **Up** or **Down** arrow keys.
- 4. A message appears if your entry is not acceptable. The tool automatically reverts to the last acceptable value. Read the on-screen tip and adjust the value as advised.
- 5. (Optional) Click the **Restore Defaults** button to revert all fields back to their original values.
- 6. Continue to the next topic to generate a schematic.

3.4 Create a Schematic and Save Your Design

In the two previous procedures, you selected a part to create a new design and entered your design requirements. Follow these steps to generate a schematic that meets those requirements and save a new design.

1. When all your values have been entered on the **Design Requirements** page, click **Create Design**.
2. The EE-Sim tool performs a complex set of calculations to design a circuit that meets your requirements. The tool selects commercially available components to satisfy your design requirements, and a visual representation of your design appears on the **Schematic** page. Click the **Save** button or the **Save Design** link to save your design. In the **Save Your Design** window:
 - a. In the **Design Name** field, enter a unique name to differentiate this design from your other designs as well as the shared designs of other users.
 - b. In the **Design Description** field, enter a short description of the design to remind you later of its purpose. The description is also helpful for any recipients if you decide to share the design.
 - c. Click **Save**.

3.5 Next Steps

Congratulations! You generated a schematic and saved your design. You can now perform one or more of the following tasks:



Task:	Step:	Learn More:
Adjust your design requirements:	Click the Design Requirements tab to change the design requirements, then click Create Design to generate a new schematic. A new version of the design is added to the History.	3.3 Specify Input, Output, and Other Design Requirements
Run simulations:	Click the Schematic tab and click Simulation .	3.7 Simulation and Analysis
Edit your schematic:	Click the Schematic tab.	3.6 Edit a Schematic
Compare design versions:	Click the Compare tab.	3.8 Compare Design Iterations
View a summary report of your design and download a BOM:	Click the Report tab and perform any of the available design and download options.	3.9 Generate a Design Report and BOM (DC-DC)
Download your designs:	Click the Download tab and perform any of the available options.	5.4 Download a Schematic

NOTE: Although there is an implied left to right sequence among the application tabs, you are not required to visit every tabbed page. For example, you could click the **Report** tab to generate a report without running any simulations and without viewing the **Compare** tab.

3.6 Edit a Schematic

3.6.1 Edit Component Properties

Change the properties of the components in your schematic as described below. Some components are considered *critical* to the design and other parts are not. When adjusting critical component values, the application flags them for your attention by applying a highlight color to both the component you changed and the **Recalculation** button. This change in appearance alerts you to edits that impact the values in other components. These impacted values can be recalculated.

1. Open a design and click the **Schematic** tab.
2. To adjust the basic visual settings of parts, including fill color, line color, dash, and width, right-click a line or component and adjust the settings available in the pop-up menus. Define custom colors by their RGB, HSB, or hexadecimal values.
3. Double-click a component to open it, or right-click a component and choose **Properties**.
4. In the **Edit Properties** window:
 - a. Click + to expand a section to view its available properties. Click - to collapse a section.
 - b. For critical components, observe the appearance of the following message:
 **This is a critical component. Changing values might require a re-calculation.** Changing a critical component can substantially alter the performance of the circuit. After changing critical component values, recalculation is recommended.
 - c. For critical components, observe the appearance of the  **Unlocked** message. Lock a critical component to prevent its values from changing later when you click **Recalculation**. Click the checkbox to toggle this setting between **Locked** and **Unlocked**.
 - d. In the **Component Information** section locate the **Part Data** field. Click **User-Defined** to set your own custom component parameter values or click **Vendor** to view the currently selected component. Click **Select Vendor Part** to view a list of other parts that meet your filter criteria. To learn more, see 3.6.2 Select a New Vendor Part.
 - e. Click **Apply**.
5. Continue editing the schematic as necessary. After editing a critical component, the **Recalculation** button and the critical component changed appear in an orange color.
6. When edits are complete, click **Recalculation**. A warning message appears to advise that unlocked component values might change. To continue with the recalculation, click **Yes**. To go back and adjust which components are locked and unlocked, click **No**.
7. After performing a recalculation, evaluate the design changes by observing the schematic or use the **Compare** tab to see a list of differences between the current version of the design and any prior versions in the history. Continue to adjust the values and recalculate as often as needed.
8. Click **Save** when complete.

NOTE: Each time you recalculate, a new version of your schematic is added to the version history for the current design.

1 Part Number: MAX20008
Design Name: Save Design

Right click a component to view its properties or change vendors. Use the buttons below to show design versions, recalculate component values, or run simulations.

Help

History **Recalculation** Simulation

2

4

5

3 Legend

- Changed Critical Value
- Locked Critical Value

Components representing open circuits: 1GΩ Resistors, 1F Capacitors
Components representing short circuits: 1mΩ Resistors

- 1 Click the part number or PDF icon to view the data sheet. Click **Save Design** or the **Save** button at right to save your new design.
- 2 When the **Recalculation** tab is highlighted, click it to perform adjustments to your schematic based on pending changes you made to critical components.
- 3 As the **Legend** reminds you, critical components with changes are flagged in the diagram in orange (**C1**). Critical components with locked values appear in green (**L1**). Critical components that have been changed and are locked appear in both colors (**C7**).
- 4 Double-click or right-click a component to change vendors or enter User Defined Properties. Critical components feature an orange banner at the top of the properties window. A component shows its locked or unlocked state with a checkbox on the properties window and a padlock icon that appears in the locked or unlocked state.
- 5 Use the new schematic toolbar to apply annotations, zoom and pan, and export the schematic image.

3.6.2 Select a New Vendor Part

Component values, secondary parameters, and even specific manufacturer part numbers for most components in the schematic can be changed. Choose from a library of appropriate purchasable components or just supply the key values for a component without selecting a purchasable part.

1. Open a design and click the **Schematic** tab.
2. Double-click a component to open and edit it, or right-click a component and choose **Properties**. In the example shown below, the C2 capacitor from a MAX15066 design is opened in the schematic diagram.
3. In the **Edit Properties** window:

- a. If it is not already expanded, click + to expand **Component Information**.
- b. In the **Part Data** field, choose **Vendor Part** to view the chosen manufacturer and part number.

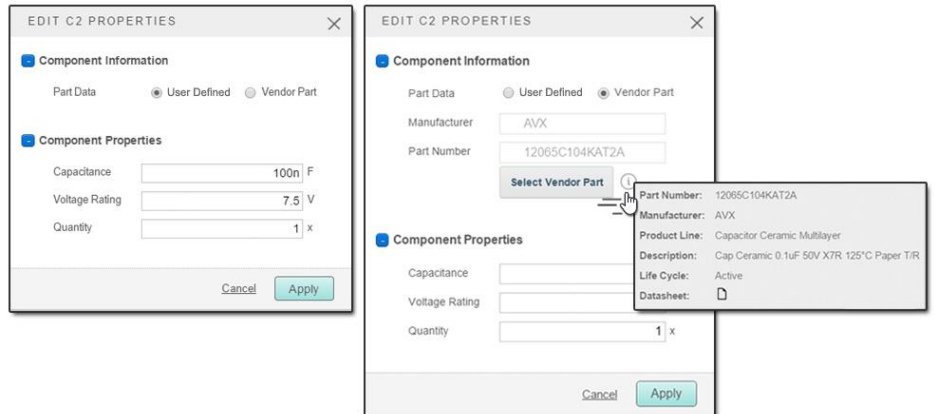

- c. Click the **Select Vendor Part** button to view a list of other parts that satisfy the requirements for this design. Also visible are the filter settings used to select these parts from the part database.
- d. Search for a different part by modifying one or more filters to search for the required manufacturers, attributes, and products.
- e. Click **Update Results** to view a list of potential matching parts. To learn more, click the "**Link**" link below a part. When ready to select a different part, click the entry to swap the old part for the new one.
- f. Review the fields in the **Component Properties** section. For example, **Capacitance**, **Voltage Rating**, and **Quantity**.
- g. Click **Apply**.

Applying filters to select a different vendor part is demonstrated in the graphic on the next page.

1 C4

Filters:

Filter Shortcuts: [Apply Default Filters](#) [Restore My Last Filters](#) [Clear All Filters](#) [Help](#)

Update Results

Capacitance at Bias Voltage

Capacitance

Min Max

6.00u F 22.0u F

Bias Voltage

3.30 V

Nominal Capacitance

Min Max

5.40u F 30.0u F

Rated Voltage

Min Max

3.96 V 100 V

Results:

5 Search

Currently Selected: GRM21BR71A106KA73L - Murata Manufacturing Cap 10uF 10V X7R 0805 10% 1.01mOhm 0.41nH Active

Applied Filters 3

Capacitance at Bias Voltage	Nominal Capacitance	Rated Voltage	Temperature Coefficient	Package/Case
6u to 22u	5.4u to 30u	3.96 to 100	X7R	1210 (3225 Metri 0805 1206 1210 1210

4

Murata Manufacturing - GRM21BR71A106KA73L
Cap 10uF 10V X7R 0805 10% 1.01mOhm 0.41nH Active [Link](#)

Murata Manufacturing - GRM21BZ71C106KE15
Cap 10uF 16V X7R 0805 10% 3mOhm 0.46nH Active [Link](#)

Murata Manufacturing - GRM21BR70J106KA73
Cap 10uF 6.3V X7R 0805 10% 3.52mOhm 0.41nH Active [Link](#)

Samsung - CL31B106KAHNNNE
Cap 10uF 25V X7R 1206 10% 4.16mOhm 0.74nH Active [Link](#)

Murata Manufacturing - GRM31CR71C106KA12
Cap 10uF 16V X7R 1206 10% 2.6mOhm 1.1nH LTB [Link](#)

Murata Manufacturing - GRM21BR71A106KA73
Cap 10uF 10V X7R 0805 10% 3.6mOhm 0.41nH Active [Link](#)

Murata Manufacturing - GRM21BZ70J226ME44
Cap 22uF 6.3V X7R 0805 20% 6mOhm 0.03nH Active [Link](#)

Murata Manufacturing - GRM31CR70J106KA01
Cap 10uF 6.3V X7R 1206 10% 3.3mOhm 1.2nH LTB [Link](#)

KEMET Corporation - C1206C106K4RAC
Cap 10uF 16V X7R 1206 10% 3.9mOhm 1.46nH Active [Link](#)

TDK - C3216X7R1C106K160AC
Cap 10uF 16V X7R 1206 10% 3.5mOhm 1.5nH Active [Link](#)

TDK - C2012X7R1A106K125AC
Cap 10uF 10V X7R 0805 10% 0.9mOhm 0.84nH Active [Link](#)

TDK - C2012X7R1A685K125AC
Cap 6.8uF 10V X7R 0805 10% 2mOhm 0.94nH Active [Link](#)

Murata Manufacturing - GRM31CR71A226ME15L

1 Selected Part: The top of the window shows the currently selected part.

2 Available Filters: This section lists search options. Default settings are based on the design requirements that you entered for your design before generating the schematic and best practices for this part as determined by Maxim’s applications engineers. If changes are made to the filter settings such as widening a filter, you can get parts that no longer satisfy the needs of the circuit. Do so with care and proper circuit design knowledge. For items with sliders, either move the sliders or modify the data in the boxes at either end of the sliders. After making any changes to the filter settings, click the **Update Results** button to find the parts that match your newly modified criteria. Click **Apply Default Filters** to restore default values and **Clear All Filters** to remove all values, which allow you to start the filtering process *from scratch*. Click **Restore My Last Filters** to undo your most recent “Update Results” click.



3 Applied Filters: This section reminds you of the search criteria used to generate the current list of matching parts.

4 Results: Click on the part number or description to replace the currently selected part with this new one. Click [Link](#)  for a part number to learn more about the product and manufacturer.

5 Search: Search for a specific component (filters are not applied).

3.6.3 Annotate a Schematic Using the Toolbar







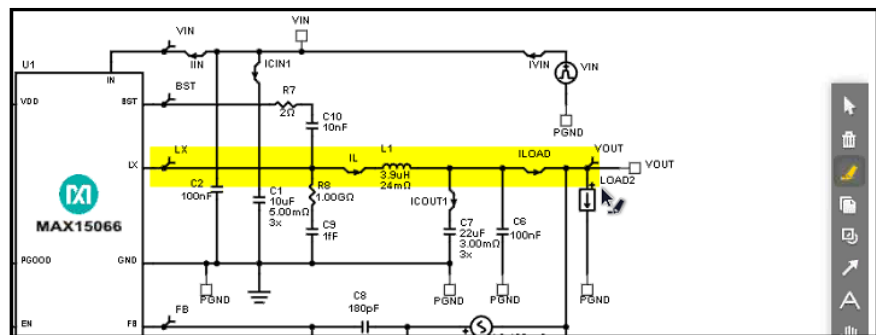

Use the convenient toolbar to annotate, markup, adjust the view, resize, or export an image of your schematic.



1. Open a design and click the **Schematic** tab.
2. To adjust the basic visual settings of parts, including fill color, line color, dash, and width, right-click a line or component and adjust the settings available in the pop-up menus. Define custom colors by their RGB, HSB, or hexadecimal values.
3. To select specific components and adjoining lines in the schematic, click  **Select Items**. For example, change the line and fill colors or export an image of a selected item. This standard mouse pointer is the default toolbar button setting. To select multiple components at the same time, click down once and drag a box around multiple parts.
4. To delete a specific shape, text, highlighted area, or other annotation, click  **Delete Items**. Position the pointer with the small trash can over the annotation items you want to delete and click each one to remove them.

Tip: Click **Undo** if you accidentally delete an item and want to restore it. Circuit components are protected and cannot be deleted.



5. To highlight an area of interest (for example, a high-current path), click  **Draw Highlight**, then mark up a specific section in your design by clicking and dragging. An example appears below:



6. To copy the schematic as an image, click  **Copy Image to Clipboard**. Paste the schematic image to another application such as Word or PowerPoint.
 - a. Click  **Copy Schematic Window Image to Clipboard** to take the current view adjustments made to the schematic into consideration. Only the portion of the schematic that fits within the current browser window is copied.
 - b. Click  **Copy Complete Schematic Image to Clipboard** to ignore any custom view adjustments (zoom, pan). The entire schematic is copied.
 - c. Either option generates a small .png file in your browser. Right-click the image and save the file to your computer or copy the image to your computer's internal clipboard. To paste the image, click Paste-Special and choose Device Independent Bitmap.
 - d. Click **Close**.
7. To draw a circular or rectangular shape around one or more components, click  **Shape Tools**. Then, specify the type of shape you want to add ( **Draw Ellipse** or  **Draw Rectangle**). Click and drag directly on the schematic to draw a circle, oval, rectangle, or square shape. To insert text, double-click the shape outline. Right-click the shape to change the font and colors.
8. To draw arrows in the schematic, click the  **Draw Arrow** tool.
9. To annotate the schematic with a short custom text block, click  **Text Box**.
 - a. Click the area of the design where you want the text to appear.
 - b. In the resulting **INPUT TEXT** box, type your custom text and click **Apply**.







- c. Right-click a text box to change the font and colors.
10. To adjust the position of the schematic in your browser window, click  **Pan**. Click and hold down the mouse button to drag the schematic in any direction.
11. To adjust the magnification of the schematic, click  **Zoom Tools**. From left to right, zoom options include:
- **Reset Zoom:** Click this option to restore the original magnification to the default zoom of 100%.
 - **Zoom to All Components:** Click this option to magnify the view in or out to a standard size that fits all components into the available view.
 - **Zoom Out:** Reduces the magnification to view more components; however, they appear at a smaller size.
 - **Zoom In:** Increases the magnification to view fine details about specific components; however, zooming in shows fewer components.
 - **Area Zoom Tool:** Define a box around a particular component or set of components to zoom in on a precise area.
12. To step back in time and undo the last action that you applied to the schematic, click  **Undo Last Action**. Use this command to erase unwanted edits such as components that you accidentally added, moved, adjusted, or deleted. When the command is not available, the icon is grayed out to indicate that there is no recent action to undo.

NOTE: Some actions cannot be undone. For example, if you resize a text box, you cannot undo this action by clicking Undo. Instead, resize the text box again.

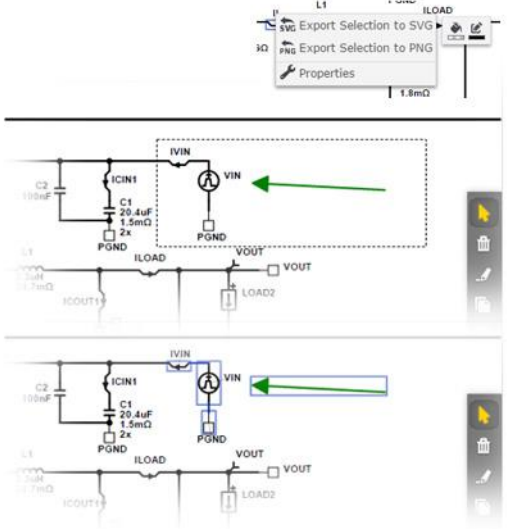
13. To reverse an **Undo** command, click  **Redo Last Action**. When the command is not available, the icon is grayed out to indicate that there is no recently undone action to redo.
14. To export an image of the schematic, click  **Export Schematic Image**. Select one of the following image formats, then click **Export File**:
- Bitmap (BMP)
 - JPEG (JPG or JPEG)
 - Portable Network Graphics (PNG)
 - Scalable Vector Graphics (SVG)
 - Tagged Image File Format (TIF or TIFF)
 - Windows Metafile (WMF)

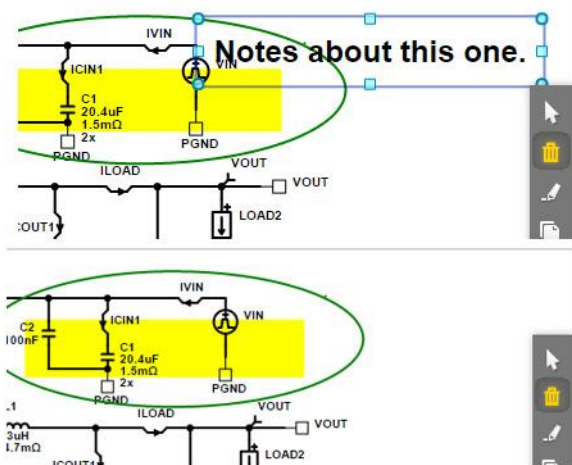
3.6.4 Schematic Toolbar Reference Chart

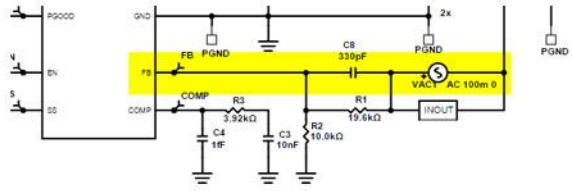
Refer to the following examples when working with the schematic toolbar.

Toolbar Button:	Function:	Examples:
 <p>Select Items</p>	<p>Selects components, annotations, and groups of both (multi-select inside a screen area that you define).</p> <p>Standard mouse pointer used for right-clicking components and annotations to set properties.</p> <p>Can also be used to click an annotation to select it and press the Delete key to remove the item.</p>	
 <p>Delete Items</p>	<p>Deletes the selected annotation item. In this example, custom text notes are deleted.</p>	
 <p>Draw Highlight</p>	<p>Highlights an area in the schematic.</p>	
 <p>Copy Image to Clipboard</p>	<p>Expands to show two options for copying the current schematic.</p>	

Toolbar Button: Function: Examples:

 Copies only the portion of the schematic that is visible in the window.

Copy Schematic Window Image to Clipboard

PLEASE USE RIGHT CLICK TO COPY IMAGE TO CLIPBOARD

Copy this image to paste it into a document

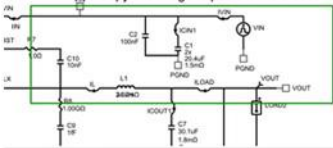

Copy

 Copies the entire schematic.

Copy Complete Schematic Image to Clipboard

PLEASE USE RIGHT CLICK TO COPY IMAGE TO CLIPBOARD

Copy this image to paste it into a document or report.

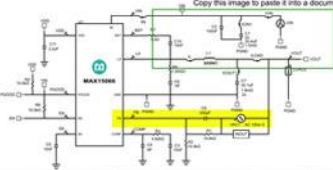

Copy

 Shows the options for drawing shapes.

Shape Tools



 Draws an oval or circle.

Draw Ellipse

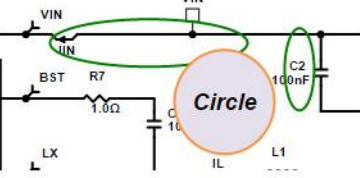

 Draws a rectangle or square.

Draw Rectangle

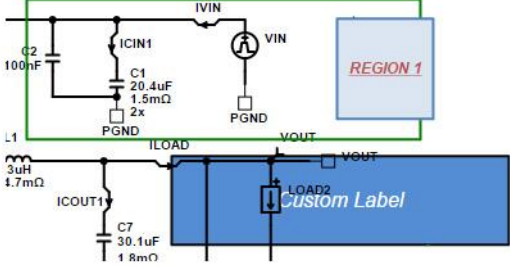

 Draws an arrow.

Draw Arrow



 Allows you to enter text. When you click Apply, the text is inserted in the schematic.

Text Box

INPUT TEXT







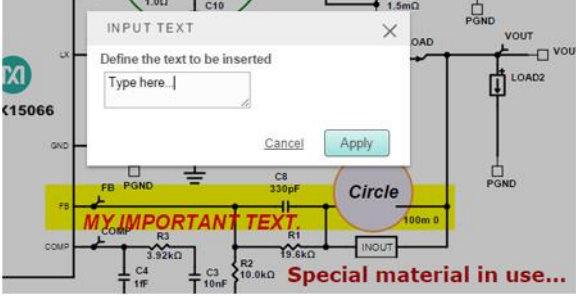

Define the text to be inserted

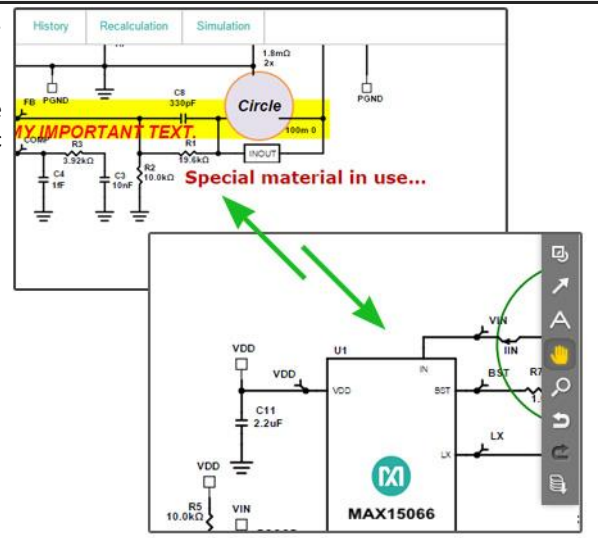

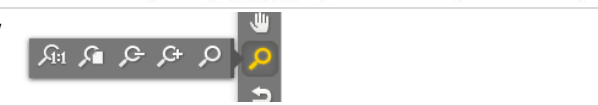

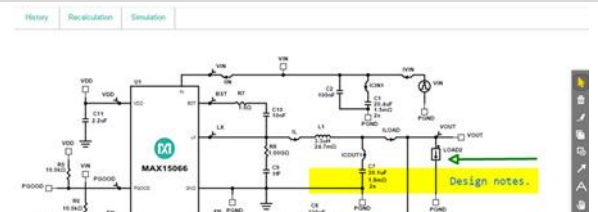

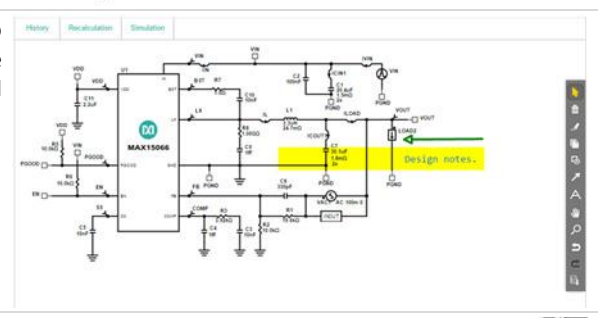
Type here..

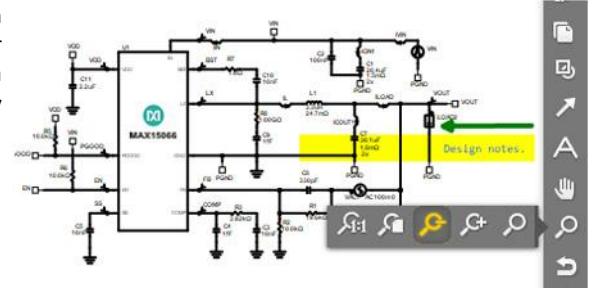
Cancel Apply

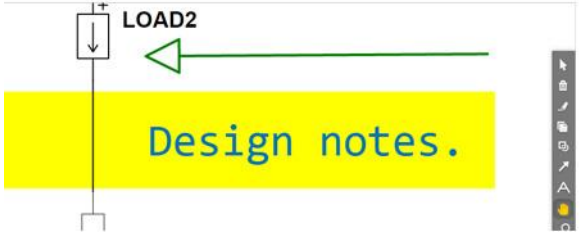

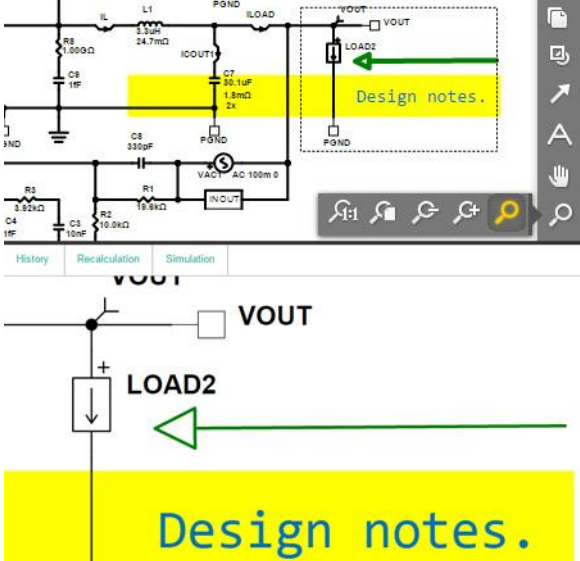
Special material in use...

Toolbar Button:	Function:	Examples:
 Pan	<p>Moves the schematic up, down, left, or right.</p> <p>Tip: After you zoom in, pan the image to pinpoint specific regions.</p>	
 Zoom Tools	<p>Expands to show the view magnification (zoom) options.</p>	
 Reset Zoom	<p>Resets any previous zoom settings and restores the default view.</p>	
 Zoom to All Components	<p>Fits the entire schematic onto the current page. The image appears smaller because all components are included.</p>	
 Zoom Out	<p>Zooms out one level. With each click, the image appears smaller because the view is relative to a point that is going out, away from the schematic.</p>	

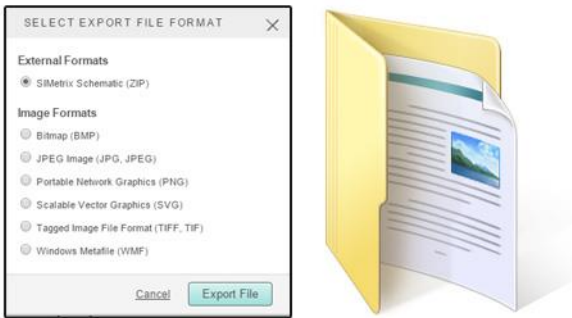
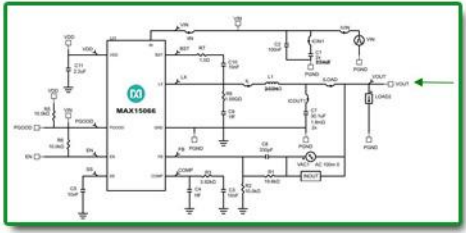
Toolbar Button:	Function:	Examples:
 Zoom In	Zooms in one level. With each click, the image appears larger because your view is relative to a point that is going in, closer to the schematic.	
 Area Zoom Tool	Defines an area in the schematic, then magnifies it (zooms in) to show as much of it as possible in the current view. In this example, the user defines the rectangle around the Design notes text and arrow (top) with the Area Zoom Tool before it expands (bottom).	
 Undo	Reverses the last action. This command is not always available.	
 Redo	Reverses the last undone action. This command is not always available.	
 Export Schematic Image	Choose an image format for exporting the schematic to an image file. Import the image file to Word, PowerPoint, and other applications.	 

3.6.5 Version History

The DC-DC Converter Design tool automatically stores versions of your design as you work. Changes in design requirements and recalculated schematics trigger a new major version; changes in device values are recorded as minor versions.

While working on your design, you can go back at any time and retrieve any of these versions with all their values and simulation results preserved. When you save your design, all versions of the design are also saved with it.

NOTE: Although simulation data is not saved when you exit your design, having all versions of the design saved enables you to rerun simulations if needed. Knowing your designs are saved with such an audit trail enables you to work with confidence.

1. Open a design and click the **Schematic** tab.
2. Click **History**.
3. Review the list of schematic versions. For example, from the bottom of the list to the top, you might see the following:

The screenshot displays the Maxim Integrated design tool interface. At the top, there are navigation tabs: New, My Designs, Maxim Designs, Design Requirements, Schematic, Compare, Report, and Download. Below these, the Part Number is MAX15066 and the Design Name is 20150607-15066-DAMON-01. A message states: "There was an error while creating your design. We apologize for any inconvenience. Please try again." Below this, there are tabs for History, Recalculation, and Simulation. The History panel shows three entries: "After recalculation" (2.0, Sun Jun 07 2015 09:33:42), "Changed L1" (1.1, Sun Jun 07 2015 09:33:11), and "Initial Design" (1.0, Sun Jun 07 2015 09:31:19). Each entry has a "More" link. The "After recalculation" entry has "Save As" and "Roll Back" buttons. The "Test Results" section shows "AC Loop" with a "More" link. The schematic shows a power converter circuit with components like resistors (R6, R7, R8), capacitors (C1-C10), inductors (L1, L2), and an IC (ICIN1).

- a. The *Initial Design* identified by the major version 1.0 with the original creation date and time.
 - b. An entry representing a change in your schematic identified by the minor version 1.1 and showing a more recent date and time. For example, you may have changed the L1 inductor value of the component and this change was recorded as *Changed L1* and version 1.1 of the original design.
 - c. An *After Recalculation* version identified as major version 2.0 that was automatically created after performing a recalculation.
4. To view additional options, click **More**.
 - a. To create a new design from a previous version, select a version, then click **Save As**. This feature creates a new version 1.0 design from the selected version.
 - b. To restore a previous version, select a version, then click **Roll Back**. For example, in the series from 2.1 to 2.2 to 2.3, say 2.2 introduced an unwanted value into your design unknowingly carried forward into 2.3. Or, something important in 2.1 was left out of subsequent versions. In both examples, you want to go back to version 2.1 of the design. Roll back the design to restore the state of the design at that time.
 - c. To examine the available test results associated with a previous version, click their links under **Test Results**.

NOTE: When you roll back to a previous version, all subsequent versions are lost. As a precaution, click **Save As** to make a backup of the latest version. Then, roll back without concern for the lost history.

When you save a design, it is saved along with all its history but not the simulations for each step in the history. It is only while working in a single session on a design that its entire history for that session is available. When you save a design, no matter where it is in the history, only that specific version is saved (without the simulation data).

3.7 Simulation and Analysis

3.7.1 Run a Simulation and Generate Waveforms

The DC-DC Converter Design tool typically provides six different analysis types to evaluate your designs. Each type is preconfigured to provide useful waveforms; however, these settings can be overridden. There is no need to learn to use the underlying simulator because this tool takes care of that for you.

Run any combination of the six different analysis types. The results from each simulation type are displayed in their own separate window. To set up and run a simulation:

1. Open a design and click the **Schematic** tab.
2. Click **Simulation**.
3. In the **SIMULATION SETUP** window, select one or more simulation types. In the **SELECT SIMULATIONS** section on the right side of the window, check the box next to each simulation you want to run.
4. For each simulation checked, select the corresponding tab to see the default values for the simulation settings. While the default settings for the simulations typically provide the results that you need, they can be changed. For example, you could:
 - a. Click **Load Step** and enter values for the simulation **Stop Time**, the Input voltage and its source resistance as well as all the load parameters. The waveform diagram represents the load step over time. The diagram is updated as you change the load parameters. The simulation time defined by the **Stop Time** field is indicated with a gray background.
 - b. Click **AC Loop** and set the **Start Frequency**, **Stop Frequency**, **Input Voltage**, and **Load Current** settings for the loop Bode plot.
 - c. Click **Steady State** and adjust the **Input Voltage** and the **Load Current**.
 - d. Click **Line Transient** and adjust the **Stop Time**, **VIN** values, and **Load Current**. The waveform diagram represents the line voltage transient over time. The diagram is updated as you change the **VIN** voltage and time parameters. The simulation time defined by the **Stop Time** field is indicated with a gray background.
 - e. Click **Start Up** and enter the simulation **Stop Time**, **Input Voltage**, and **Load Current**.
 - f. Click **Efficiency** to adjust the number of calculation **Points**, **Input Voltage**, and load **Start** and **Stop Current settings**. (Efficiency results are calculated instead of simulated.)
5. Click the **Run Simulations** button. All the simulations that you selected are run.
6. When a test is complete, a View Waveforms area is added at the top left section of the Simulation Setup window. Click on a simulation name to examine its waveforms in the Weboscope waveform viewer.
7. Make changes to the simulation parameters and re-run any number of simulations.
8. Click **Save and Close** when finished to save the simulation parameters.

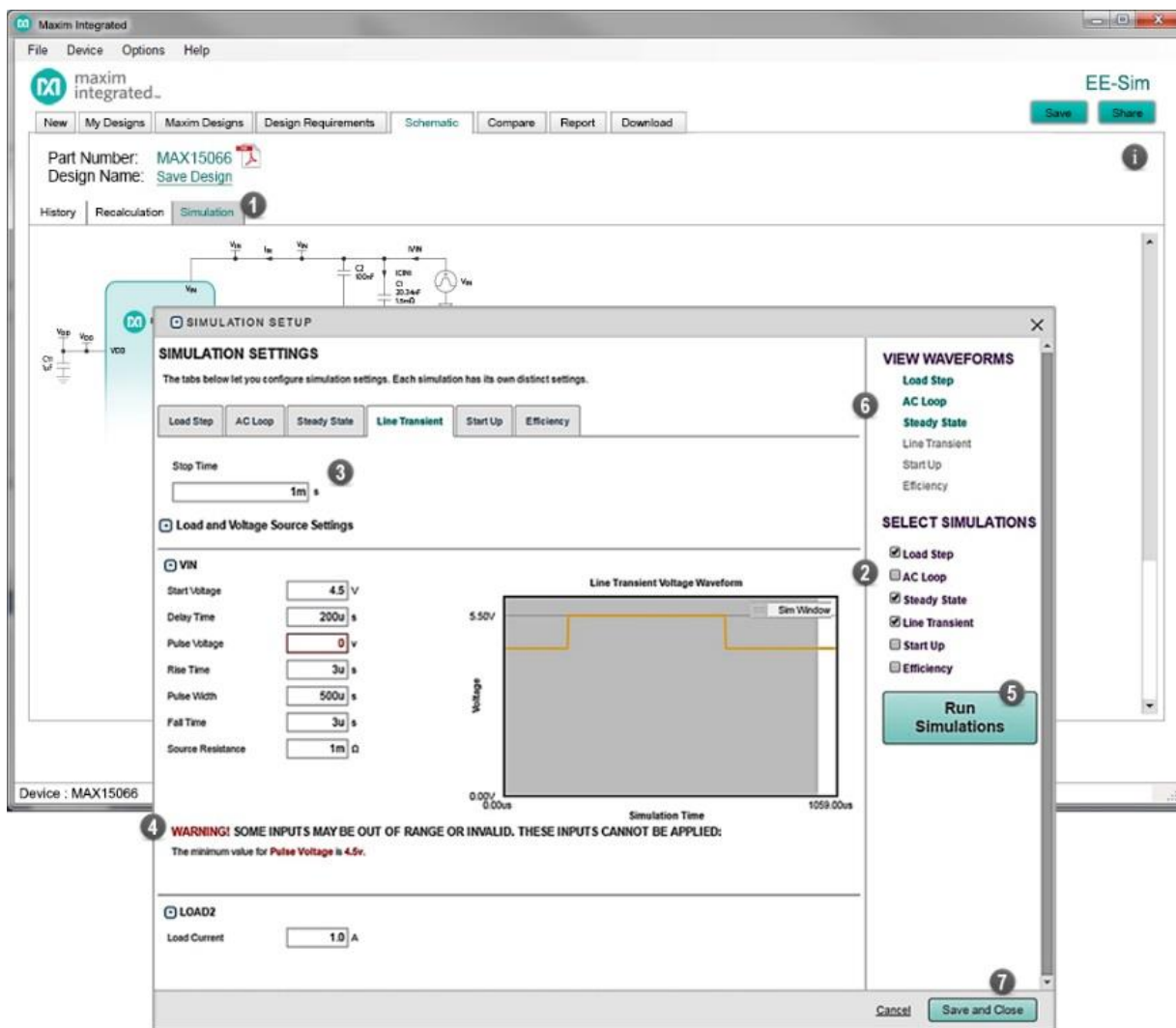

- 1 On the Schematic page, click the **Simulation** button.
- 2 Select the check box for each simulation type you want to run. In this example, the Load Step, Steady State, and Line Transient runs next time the **Run Simulations** button is clicked.
- 3 Click a tab to customize the simulation settings.
- 4 When editing field values, warning text appears to alert you when a setting is too low or too high. Invalid entries appear in red. These values must be corrected. You cannot run a simulation with invalid entries.
- 5 Click **Run Simulations** to run each checked simulation.
- 6 To view simulation results, click the corresponding teal link in the upper right area of the window.
- 7 Click **Save and Close** to save your simulation selections for your current session. If you click Save and Close, invalid entries (in red) are not saved. The field values revert to their last valid entries.

3.7.2 View Simulation Waveforms

After clicking **Run Simulations** (see previous section), each completed simulation type displays a link to show the results. For example, click **AC Loop** or **Load Step**. When you click the results link, expect to see the following graphs on their own separate tabs in a separate WebScope waveform viewer browser window for each test:

- **Load Step:** The many time-domain voltages and currents are grouped logically. While the groupings can vary, the most common groups are:
 - **IC:** Displays voltages of various pins on the IC that do not belong in the other groups.
 - **Input:** Displays current and voltage waveforms related to the input.
 - **Switching:** Displays current and voltage waveforms related to the switching transistors and nearby circuitry.
 - **Output:** Displays current and voltage waveforms related to the output.
- **AC Loop:** This simulation produces the simplest set of waveforms.
 - **Bode:** Displays a Bode plot of the feedback loop for each output. Frequency is plotted on the horizontal axis using a logarithmic scale. The first vertical axis is the gain in decibels (dB). A second vertical axis is phase in degrees.
- **Steady State:** The many time-domain voltages and currents are grouped logically. While the groupings can vary, the most common groups are:
 - **IC:** Displays voltages of various pins on the IC that do not belong in the other groups.
 - **Input:** Displays current and voltage waveforms related to the input.
 - **Switching:** Displays current and voltage waveforms related to the switching transistors and nearby circuitry.
 - **Output:** Displays current and voltage waveforms related to the output.
- **Line Transient:** The many time-domain voltages and currents are grouped logically. While the groupings can vary, the most common groups are:
 - **IC:** Displays voltages of various pins on the IC that do not belong in the other groups.
 - **Input:** Displays current and voltage waveforms related to the input.
 - **Switching:** Displays current and voltage waveforms related to the switching transistors and nearby circuitry.
 - **Output:** Displays current and voltage waveforms related to the output.
- **Start Up:** The many time-domain voltages and currents are grouped logically. While the groupings can vary, the most common groups are:
 - **IC:** Displays voltages of various pins on the IC that do not belong in the other groups.
 - **Input:** Displays current and voltage waveforms related to the input.
 - **Switching:** Displays current and voltage waveforms related to the switching transistors and nearby circuitry.
 - **Output:** Displays current and voltage waveforms related to the output.
- **Efficiency:**
 - **Efficiency Plot:** Displays efficiency as a percentage for a range of output current.
 - **Power Loss Plot:** Displays power loss in watts for a range of output current.

NOTE: Some parts may not utilize all six (6) analysis types. Some parts offer application specific simulation types not shown above.

3.7.3 Customize the Waveform Viewer Output



Use the WebScope waveform viewer to see the simulation results in a graph with table entries appearing at the bottom. The waveform viewer does a *smart autoscale* for each vertical axis. Rather than using the maximum and minimum Y values from the waveforms as the visible scale limits, it chooses slightly larger limits so that the major divisions have relatively simpler values (with fewer non-zero significant digits) and aligns the grids for multiple vertical axes. The autoscale feature improves the visual appearance of the waveforms and makes it much easier to work with them.

Refer to the following sections to customize the waveforms:

- 3.7.3.1 Customize the Waveform Tabs
- 3.7.3.2 Customize the Waveform Axes and Markers
- 3.7.3.3 Capture Precise Waveform Data Using Markers
- 3.7.3.4 Customize Your View of the Waveform Graph Using the Toolbar
- 3.7.3.5 Add a New Waveform to the Current Graph

- 3.7.3.6 Add a Custom Tab to the Waveform Simulation Results

3.7.3.1 Customize the Waveform Tabs

1. At the top of the page, click through the tabs to view the related waveforms available for each simulation.
2. To change the color of a data element in the graph, click its color-coded square in the Legend and choose another color.
3. Right-click anywhere on the graph and choose one of the following options for working with tabs:
 - a. **Edit Tab:** Specify the appearance of the current tab including its name (for example, **OUTPUT**), graph stacking method, annotation used when saving the image to the report, zoom factor (1.5 is the default ratio used when you zoom the current view in or out), and the height and width of the image saved to the report when you click  **Include in Report**,  **Copy to Clipboard** or  **Download as file** (default is 400 pixels wide by 300 pixels high).
 - Set the **Graph Stack Method** to *Not Stacked* to plot all the output in the same graph.
 - Set the **Graph Stack Method** to *Stacked* to plot each waveform on individual graphs with the graphs stacked vertically.
 - Set the **Graph Stack Method** to *Stacked for all y-axes* to group the graphs by voltage (V) and Current (A).
 - b. **Add a Tab:** Add your own custom tab. As a shortcut, click **+ on the rightmost tab** to add a custom tab.
 - c. **Clone Tab:** Create a new tab by duplicating an existing one, then modifying it.
 - d. **Remove Current Tab:** Removes the currently selected tab.

3.7.3.2 Customize the Waveform Axes and Markers

Customize the appearance of the axes and markers.

1. **Edit Graph:** Customize the appearance of the current graph with the following options:
 - a. To specify the number of vertical markers that appear along the X-axis, enter a number between 0 and 5 in the **Number of Vertical Markers** field.
 - b. To specify the number of horizontal markers that appear along the Y-axis, enter a number between 0 and 5 in the **Number of Horizontal Markers** field.
 - c. In the **Handling of Multiple Grids** field, select the type of axis synchronization that you want to see (show all grids, show one grid, or synchronize all grids). All the initial graphs have their vertical axes synchronized. Even though the values for each gridline can be different for each axis, scales are adjusted to line up gridlines, making the visual presentation clearer.
 - d. To customize the appearance of marker names (for example M1, M2 or N1, N2) and marker values displayed adjacent to the marker handles, select an option in the **Show Marker Name** and **Show Marker Value** fields. Both fields include options to show the marker name or value *always*, *never*, or *only when selected*. To select a marker, grab its triangular handle in the margin (click and hold down your mouse button), then drag and drop it.
 - e. In the **Show Border Values** field, select *On* or *Off* to show or hide the border values (i.e., the far right and far left grid lines for the X-axis and the top and bottom lines of the Y-axis). Hide border values to reduce visual clutter that can often occur in the corners of the graph.







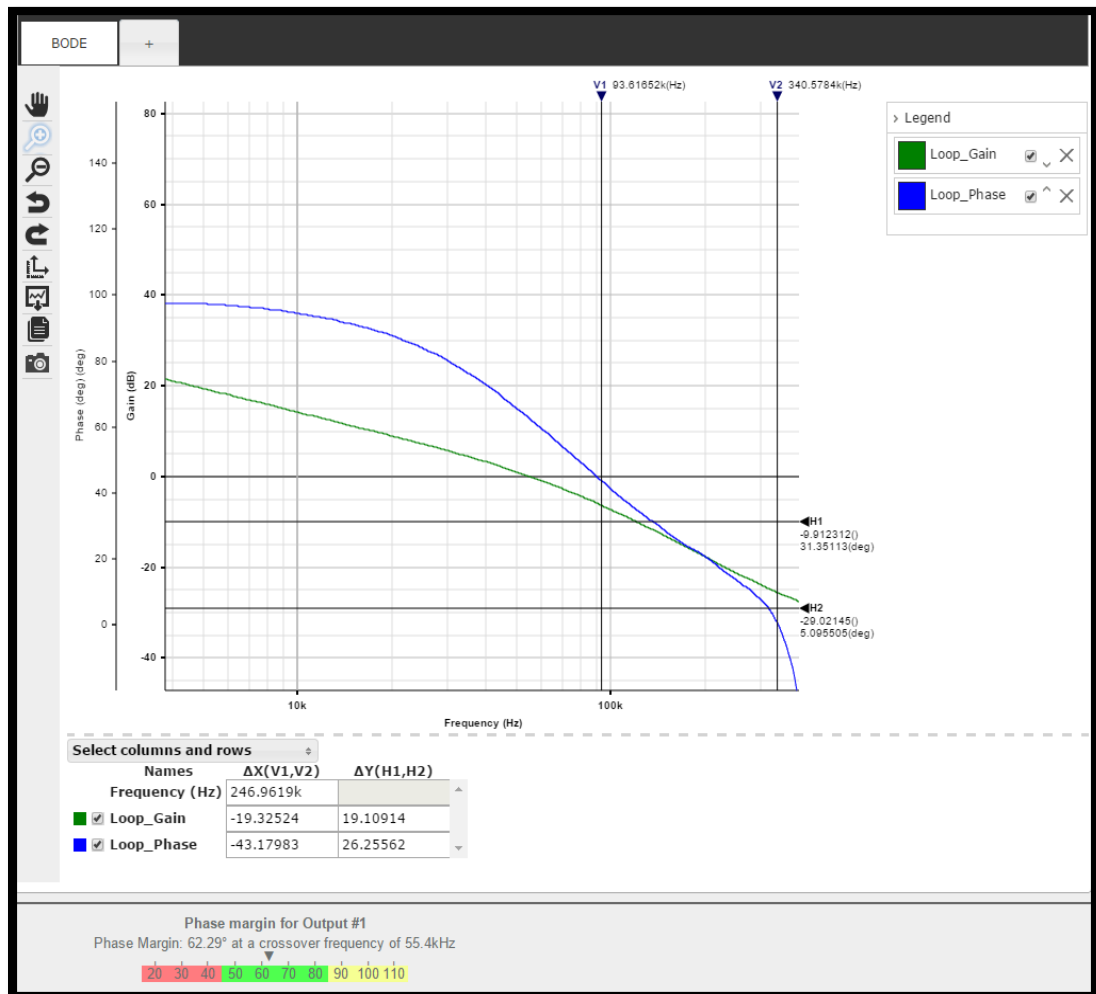



- f. In the **X-Axes Order** and **Y-Axes Order** fields, adjust the display order of the axes when more than one axis appears. Drag and drop them in sequence from top to bottom.
- To edit an axis, right-click, select **X-Axes** or **Y-Axes**, then choose an axis name. For example, click **Voltage** to edit the appearance of the voltage axis.
 - In graphs with multiple axes, the active axis appears in a bold typeface and slightly darker and thicker scale line. The active axis is used to align the values in the graph. Data points can be aligned to more than one axis. Use any of the following methods to set the active axis:
 - Click directly on the axis label.
 - Right-click, select **X-Axes** or **Y-Axes**, then click on its option button circle (sometimes called radio buttons because selecting one automatically deselects the previous one).
 - Double-click on the axis label. This option has the same result as the next option.
 - Right-click, select **X-Axes** or **Y-Axes**, then click on an axis by name to open the **Edit Axis** dialog box. Select the **Active** check box, then click **Apply**.

3.7.3.3 Capture Precise Waveform Data Using Markers

To adjust the vertical or horizontal markers, drag the black triangular handles in the margins of either axis. Drag and drop the axes to define a boundary around a specific portion of the graph. As you change the position of each guide marker, the vertical and horizontal marker data in the table below the graph also changes. Zoom in to capture precise data points within a specific region of the graph.



3.7.3.4 Customize Your View of the Waveform Graph Using the Toolbar

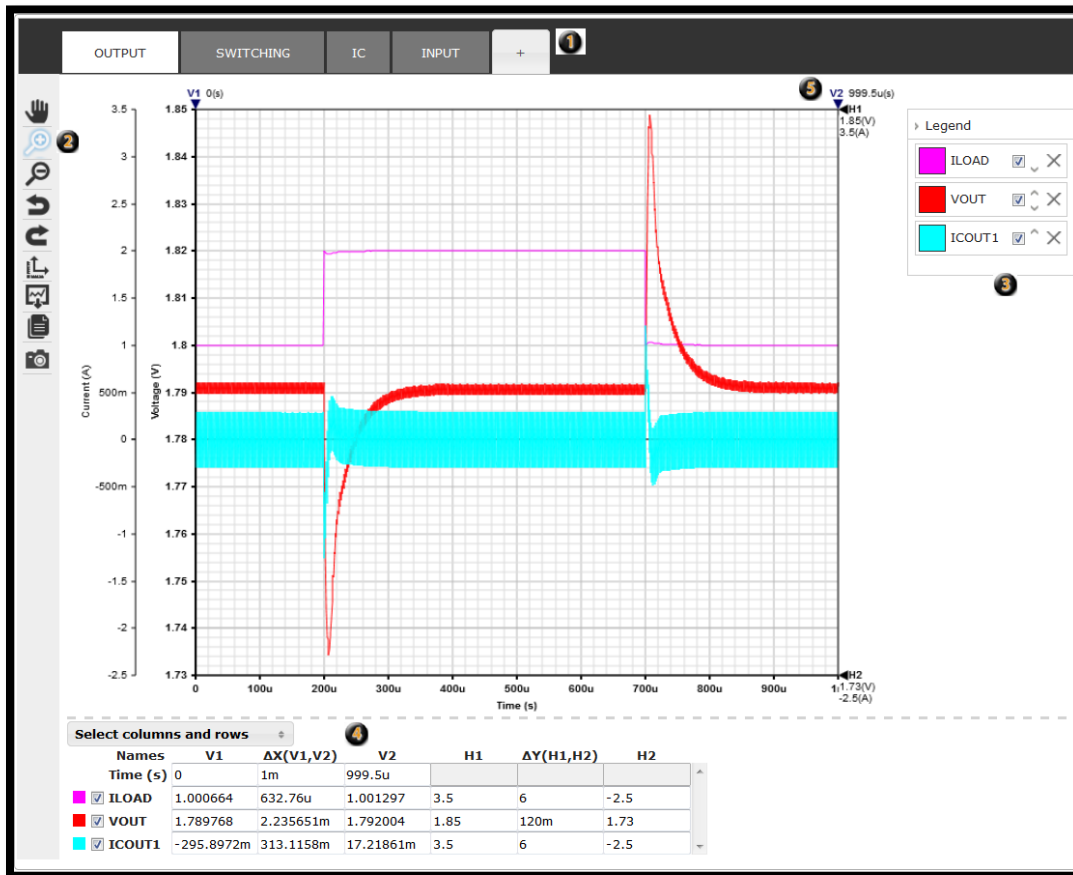

1. Use the toolbar to manipulate the graph.
 - a. Click  **Pan** to navigate within the current graph.
 - b. Click  **Zoom In** to position the manual zoom tool around a specific area that you want to enlarge. Click to the left and above the item and hold down the mouse until you reach a point to the right and below the item. This defines the rectangular area to enlarge.
 - c. Click  **Zoom In** to magnify the entire graph by one zoom level per click or define a rectangular area to enlarge.
 - d. Click  **Zoom Out** to reduce the zoom level for every click.
 - e. Click  **Undo** to discard the most recent change that you made.
 - f. Click  **Redo** to re-apply a change.
 - g. Click  **Reset Zoom** to return to the original scaling and axis synchronization of the waveforms.
 - h. Click  **Autoscale** to adjust the axes to maximize use of available space.
 - i. Click  **Download as file** to save the current graph as an image file on your computer, or download the associated data in the table. Alternatively, you can also email or share the files with others. A **Download file** dialog box appears.
 - In the **Images** section, select an image file format.
 - In the **Data** section, to download the data in the table, select a file format. Choose **Excel®** for the Microsoft Excel spreadsheet file format. You get one .xls file with separate tabs for each waveform. Choose **CSV** for comma-separated values format, popular for structuring the data for importing into a database. Choose **Text** to view the data in a plain text editor.
 - Click **Apply**. Each downloaded file appears in its own .zip archive for ease-of-use and to compress large files to a smaller size.
 - j. Click  **Copy to Clipboard** to open a preview window. Copy the current graph from the preview window to your clipboard for pasting later into another application.
 - k. Click  **Include in Report** to include the graph on the current tab in the report. To change the name of the tab, enter your own custom name. Insert any annotations that you want to appear with this graph in the final report, and click **Apply**. Custom graphs appear at the bottom of the design report. Expand the **Simulation Results** section on the **Report** tab to see any custom graphs. Add as many custom graphs as you want and decide later which ones to include or exclude from the final report.
2. When finished, close the window.



- 1 Select a tab to view the corresponding waveform output.
- 2 Use the toolbar to apply the helpful commands as you work. For example, pan and zoom, undo and redo, and update the design report with the changes made to a graph.
- 3 Use the Legend to hide and show waveforms, customize colors, and adjust the sequence.
- 4 Select the columns and rows to include in the data table.
- 5 Adjust markers to calculate the changes between data points.

3.7.3.5 Add a New Waveform to the Current Graph

One way to customize results is to add a waveform to an existing tab.

1. Right click anywhere on the graph.
2. Click **Add a Waveform to Graph** from the menu.
3. Click the drop-down menu at the top (the triangular icon facing down  indicates you can choose from a list) and select from the list of probed voltages and currents. The rest of the items below are optional. The defaults are usually appropriate.
4. If desired, change the name for this waveform in the **Name** field.
5. In the **Enabled** field, select **On** to make your waveform active. Select **Off** to disable the waveform. When disabled, the waveform is listed in the legend, but is hidden.
6. In the **Graph type** field, select the type of graph you want to build. Choose **Line**, **Bar**, **Point**, or **Step**.
7. Select the **Color** field to choose a specific color for this waveform. Click  **Other** to define a custom color by swatch, RGB, HSB, or hexadecimal values.
8. In the **Line width** field, select the thickness of the lines used to plot data in points or pixels.
9. Click **Apply**.

3.7.3.6 Add a Custom Tab to the Waveform Simulation Results

The previous section describes the many ways to change the formatting of your test results. Another powerful feature is the capability to create a new custom tab to display results. Note that naming your tab is the only required input. Accept default values for any of the other configuration choices shown below:

1. Click the **+** tab or right-click and choose **Add a Tab**.
2. In the **Name** field, enter the unique name for your new tab.
3. Set the **Chart type** to Chart.
4. In the **Number of vertical and horizontal markers** fields, enter the quantity of vertical and horizontal markers for the graph. Drag these guide lines to capture precise data point information between the graph and the data table below it.
5. In the **Handling of multiple grids** field, the default value is **Synchronize all grids**. Choose **Show all grids** if you want to view all grids on a single graph. Choose **Show one grid** to limit the display of multiple grids to just one grid.
6. In the **Show marker value** field, the default selection is **When selected**. Choose **Never** to hide the display of data point values adjacent to their marker handle, choose **When selected** to display data point values only when the marker is selected, or choose **Always** to constantly display marker data values adjacent to the marker handles.
7. In the **Show marker name** field, the default value is **When selected**. Choose **Never** to hide the marker name or choose **Always** to constantly display the names of the markers adjacent to the marker handles.
8. In the **Show border values** field, the default value is **Off**. Choose **On** to show border values.
9. Click **Apply**. The **Add Waveform** dialog box appears.
10. Click the drop-down menu at the top (the triangular icon facing down) indicates you can choose from a list) and select from the list of probed voltages and currents. The rest of the items below are optional. The defaults are usually appropriate.
11. If desired, change the name for this waveform in the **Name** field.
12. In the **Enabled** field, select **On** to make your waveform active. Select **Off** to disable the waveform. When disabled, the waveform is listed in the legend but is no longer visible on the graph.
13. In the **Graph type** field, select the type of graph you want to build. Choose **Line**, **Bar**, **Point**, or **Step**.
14. Select the **Color** field to choose a specific color for this waveform. Click  **Other** to define a custom color by swatch, RGB, HSB, or hexadecimal values.
15. In the **Line width** field, select the thickness of the lines used to plot data in points or pixels.
16. Click **Apply**.

Tip: To edit these settings, right-click and select **Edit Tab**, **Edit Graph** or choose **Waveforms** and select the specific waveform you want to adjust.

3.8 Compare Design Iterations

Compare components, design requirements and simulation differences on the **Compare** tab. As you modify your design, the major and minor versions are stored. The different versions in the history can be compared to the current version at any time.

1. Open a design with multiple versions in its history and click the **Compare** tab.
2. Verify that **Show only differences** is checked. This option limits the information that appears to the differences between the two designs. When unchecked, all information about both designs appears.
3. Click **History**:
 - a. Select an older version to compare to the newest (most recent) version.
 - b. Click **Load**.
4. Compare the changes made to each version line by line. The page shows the two versions side by side including design requirements, component values from the schematics, BOM

information for each part, and thumbnail images for the most recent simulation waveform graphs.

5. (Optional) Click a graph to open it.
6. If a simulation has been run for one version but not the other, click the **Run** button to generate and compare graphs.
7. To examine graphs of the same type for both designs in the Waveform Viewer, click **Merge Graphs**. The waveforms from both versions appear with each other in a single graph with a legend that includes the design name and version.

Also refer to the graphic on the following page when using the **Compare** feature.

maxim integrated. EE-Sim

Part Number: MAX15066
Design Name: Save Design

History Show only differences

Design Requirements changed 2.0 Sat Aug 01 2015 15:19:46 Load

Loaded Maxim Design 1.0 Sat Aug 01 2015 15:19:00 Load

R5

New My Designs Maxim Designs Compare Report Download Save Share

Part Number: MAX15066
Design Name: Save Design

History Show only differences

Item	Design Requirements changed 2.0	Loaded Maxim Design 1.0
R8	1.00GΩ	1GΩ
L1	4.7uH	5.6uH
R5	10.0kΩ	10kΩ
Performance Tradeoff	Design for Small Size	Balance Efficiency and Size
Cost Tradeoff	Use Lower Cost Components	Use Higher Performance Components
R7	1.0Ω	1Ω
C2	1x C0603C104K5RACTU KEMET Corporation Cap Ceramic 0.1uF 50V X7R 10% SMD 0603 125°C Paper T/R	1x User-Defined WebSim Capacitor - 100nF
C3	1x C1206C103K5RACTU KEMET Corporation Cap Ceramic 0.01uF 50V X7R 10% SMD 1206 125°C Plastic T/R	1x C0402C103K3RACTU KEMET Corporation Cap Ceramic 0.01uF 25V X7R 10% SMD 0402 125°C Paper T/R
C5	1x C1206C103K5RACTU KEMET Corporation Cap Ceramic 0.01uF 50V X7R 10% SMD 1206 125°C Plastic T/R	1x C0402C103K3RACTU KEMET Corporation Cap Ceramic 0.01uF 25V X7R 10% SMD 0402 125°C Paper T/R
C7	2x C3225X5R1A336M200AC TDK Cap Ceramic 33uF 10V X5R 20% SMD 1210 85C Plastic T/R	2x C4532X7R1C336M250KC TDK Cap Ceramic 33uF 16V X7R 20% SMD 1812 125C Plastic T/R

AC Loop Merge Graphs Run AC Loop

AC Loop Merge Graphs

- 1 When opening a design, the newest version automatically loads. Click the **Compare** tab to view the details associated with the newest version and compare them to any prior version.

- 2 Click the **History** button to view the list of versions. The latest version is already open so its **Load** button is grayed out. Click the **Load** button for any prior version. Tip: To reduce the volume of data in your comparison, select the **Show only differences** check box.
- 3 For each item in the list, compare the details for each of the two versions represented in separate columns. Click a part number to open a product data sheet.
- 4 In this example, the AC Loop simulation has not yet been run for one of the versions. Click **Run AC Loop** to run the simulation based on the design requirements for that version.
- 5 When both graphs have been run, the **Merge Graphs** button appears as an option. Click **Merge Graphs** to combine the data from both versions into one new graph.

3.9 Generate a Design Report and BOM (DC-DC)

3.9.1 Publish a Design Report and BOM

Follow these steps to generate, view, and save a summary report and a bill of materials (BOM) for the current design.

1. Open a design and click the **Report** tab.
2. A summary page appears with the following options:
 - a. Click **Product Folder**, **Data Sheet**, or **App Notes**, if shown, to view additional information about the part.
 - b. Click **Get an Evaluation Board**, if shown, to view a product evaluation kit with an overview, ordering information, design resources, data sheet, and related product links. (If no evaluation board exists for the part selected, the button does not appear.) Also subscribe to alerts about the selected product here.
 - c. Click **Order Samples** to search for product samples. Click the **Sample Now** button to add selected samples to your sample cart.
 - d. Click the **Buy** button to view product availability, quantities, and pricing.
3. For each version of your design, check or clear the **Include in report** check box.
4. To make detailed selections, expand a section and check or clear the check box to determine which of the following design details are included in your custom report:
 - a. **Design Requirements**: Expand this section to view the requirements.
 - b. **Schematic**: Expand this section to view the schematic diagram.
 - c. **BOM**: Expand this section to view the BOM.
 - d. **Simulation Results**: If this section appears, expand it to view your original simulation graphs. The graphs are smaller and aligned to fit for the best viewing experience in a browser, PDF file, or printed report. Any custom graphs that were added appear with their names and annotations along with the default graphs. Check or clear the **Include in report** check box for each graph to determine whether it appears in the final report. As a shortcut, click a graph to open it in the design's last saved state and modify it. Click  again to re-add the changed graph to the report.
5. Scroll back up to the top of the page (or press the Home key on your keyboard). Click **Print Preview** to print the report to any printer, network copier, fax device, or to a PDF, XPS, or other file. To save the report as a PDF file, click **Download PDF**.
6. You may also publish your design in the EE-Sim Design Gallery using the **Post to Gallery** button. After posting it in the Design Gallery, it is easy to share the design through your Facebook, WeChat, LinkedIn, or Twitter account. See Chapter 6 to learn more.

3.9.2 Download the BOM, Report, and Schematic

Download your report and Bill of Materials (BOM). Also download your schematic to edit it in the EE-Sim OASIS Simulator or the commercial version of SIMPLIS (version 7.2 or later).

1. Open a design and click the **Download** tab.
2. To download the Bill of Materials (BOM), click **BOM Export**, select a file format, and click **OK**.
The following formats are available:
 - a. **XLS**: Excel spreadsheet.
 - b. **CSV**: Comma-separated values, a format that can be viewed as a spreadsheet or imported into a database.
 - c. **TXT**: Plain text with no formatting.
3. To download the most recent design report, click **Summary PDF**.
4. To download the latest schematic, click **Schematic**. Open downloaded schematics in the offline EE-Sim OASIS Simulator or in SIMPLIS version 7.2 or later

NOTE: You are given the option of having the downloaded schematic configured as it was online for any of the simulation types available. This automatically configures the simulator settings for that simulation type. To run other simulation types, reconfigure the downloaded schematic in the simulator, or simply download the schematic again and select a different configuration.

5. To download EE-Sim OASIS, click the **EE-Sim-OASIS-Installer.exe** and follow the installation instructions on the Download page. For more information, see Chapter 8: EE-Sim OASIS Simulator.
6. (Optional) To change or annotate the report or BOM, click the **Report** tab.
7. (Optional) To change or annotate the schematic, click the **Schematic** tab.

4 System Power Designs

As a registered member of the Maxim Integrated online community, use the Maxim EE-Sim System Power tool to view custom DC-DC and sequencer recommendations for multi-rail or multi-load systems including processor, SoC, μ C, and FPGA designs. This tool automatically validates part selections based on your requirements, saving precious design time and resources. Take advantage of the following additional features:

- Share designs with colleagues.
- Design and simulate individual integrated circuits (ICs).
- Choose power sequencer ICs and view timing.
- Print a complete report.

While using the EE-Sim tools, do not forget to explore the other features and benefits of online membership with Maxim Integrated.

4.1 Create a New System Power Processor Design

Use the System Power tool to explore the components required to power your FPGA or processor. After entering detailed input requirements, generate an interactive schematic with components you can modify.

4.1.1 Create a New FPGA Processor Design and Schematic

Use this procedure to create a new power design with a **Device Type** setting of *FPGA*.

1. Click the **Home** tab.
2. Click **Start Design**.
3. On the **Design Requirements** page, in the **Device Selection** section:
 - a. In the **Device Type** field, select *FPGA*.

NOTE: The fields and acceptable values on the **Design Requirements** page automatically change based on the value chosen in the **Device Type** field.

- b. In the **Manufacturer** field, choose Xilinx or Altera.
 - c. In the **Family** field, choose the product family or series available from the manufacturer that you selected in the previous step.
 - d. In the **Device** field, choose a specific model number. The list of available devices corresponds to the product series that you selected in the Family field.
4. (Optional) To save your design click **Save**, name your design, assign a short description, and click **Save** again. Or, continue developing your design and save it later.
 5. In the **Power Requirements** section, the **FPGA Power Estimator Spreadsheet** option is automatically selected for you when you choose *FPGA* in the **Device Type** field in the previous section.

NOTE: If you change the **Device Type**, your original values are removed.

6. Click **Browse**.
7. In the **Choose File to Upload** window, navigate to your Altera or Xilinx power estimator file in a folder or on your computer. Select the file and click **Open**.
8. Click **Upload**.
9. Click **Preview Device** to view the rails and pins for your device.
 - a. Any missing values in the table appear with a red border to alert you to finish entering your design requirements.
 - b. (Optional) Combine loads with the same voltage requirement by assigning the same Group Number to them. Two or more rows with a shared group number is treated as a single rail.
10. Examine the preview image and, if necessary, adjust any values.
11. In the **Primary DC Input Voltage** section, adjust the default **Input Voltage** fields.

12. Click **Create Design**.
13. Click **Save** to save your changes.

4.1.2 Create a New Processor/ Custom Load Design and Schematic

Use this procedure to create a new power design with a **Device Type** setting of *Processor/SoC/Custom Load*.

1. Click the **Home** tab.
2. Click **Start Design**.
3. On the **Design Requirements** page, in the **Device Selection** section:
 - a. In the **Device Type** field, select *Processor/SoC/Custom Load*.

NOTE: The fields and acceptable values on the **Design Requirements** page automatically change based on the value chosen in the **Device Type** field.

- b. In the **Manufacturer** field, enter a manufacturer.
 - c. In the **Family** field, enter a product family for your choice of manufacturer.
 - d. In the **Device** field, enter a model number or product identifier.
4. (Optional) To save your design, click **Save**, name your design, assign a short description, and click **Save** again. Or, continue developing your design and save it later.
5. In the **Power Requirements** section, the **Processor/Custom Load** option is selected when you choose the *Processor/SoC/Custom Load* value in the **Device Type** field.

NOTE: If you change the **Device Type**, your original values are removed.

6. Complete one or more rows in the power requirements table:
 - a. In the **Pin Name** field, enter the unique identifier for each pin (for example, VCCO).
 - b. In the **Group** field, enter an integer number. To combine rails with the same voltage, enter the same group number for those rails.
 - c. In the **Voltage (V)** field, enter the voltage.
 - d. In the **Ireq (A)** field, enter the amperage.
 - e. In the **Supply Tolerance** field, adjust the tolerance threshold.
 - f. To delete a row, click **Delete**.
 - g. To add settings for a new pin, click **+ Add Row**.
7. Click **Preview Device** to view the rails and pins for your device.
 - a. Any missing values in the table appear with a red border to alert you to finish entering your design requirements.
 - b. Correct the conflicting voltage values if you assigned a shared group number to rows with different voltages. Enter the same voltage for each row in the group.
8. Examine the preview image and, if necessary, adjust any values.
9. In the **Primary DC Input Requirement** section, adjust the default **Input Voltage** fields.
10. Click **Create Design**.
11. Click **Save** to save your changes.

4.2 Next Steps

Congratulations. You generated a schematic and saved your design. You can now perform one or more of the following tasks:

Task:	Step:	Learn More:
Edit your requirements:	Click the Design Requirements tab.	4.1 <i>Create a New System Power Processor Design</i>
Edit your schematic:	Click the View Schematic tab.	0 <i>Modifying System Power Schematics</i>
Configure sequencing and group/rail assignments:	Click the Sequencing tab.	4.4 <i>Sequencing</i>
View a design summary, and download a BOM:	Click the Summary tab.	4.5 <i>Generate a Summary Page and BOM (System Power)</i>
Download the design:	Click the Download Designs tab.	5.4 <i>Download a Schematic</i>

4.3 Modifying System Power Schematics

4.3.1 Add and Connect Product Components

Add, connect, and change components directly in the schematic.

1. Open a system power design and click the **View Schematic** tab.
2. To add a component, click **Add Components** and choose a component from the menu. Select converters, an input power supply, an additional load, or another processor.
3. Drag the component to a specific location and release the mouse to position it there.
4. To connect components, drag circuit connection lines by their points and release your mouse button at the endpoint or to make a 90-degree turn in the line.

NOTE: To correct a mistake, click the **Undo** icon in the toolbar. To remove unwanted objects, use the **Select** tool to draw a box around them using your mouse and click the **Delete** icon to delete all objects in the marquee box.

5. Refer to the examples described in the following graphic to complete any additional tasks. For example, print, zoom, add a wire, and check a design for errors.
6. Click **Save**.
7. (Optional) When you make an active choice to click **Check Design** or a passive choice to navigate away from the **View Schematic** page, System Power validates the following design rules:
 - The voltages on a given connection match.
 - The required current is less than the supplied current.
 - The power out is equal to 80% of input power.
 - Loads do not have multiple sources.

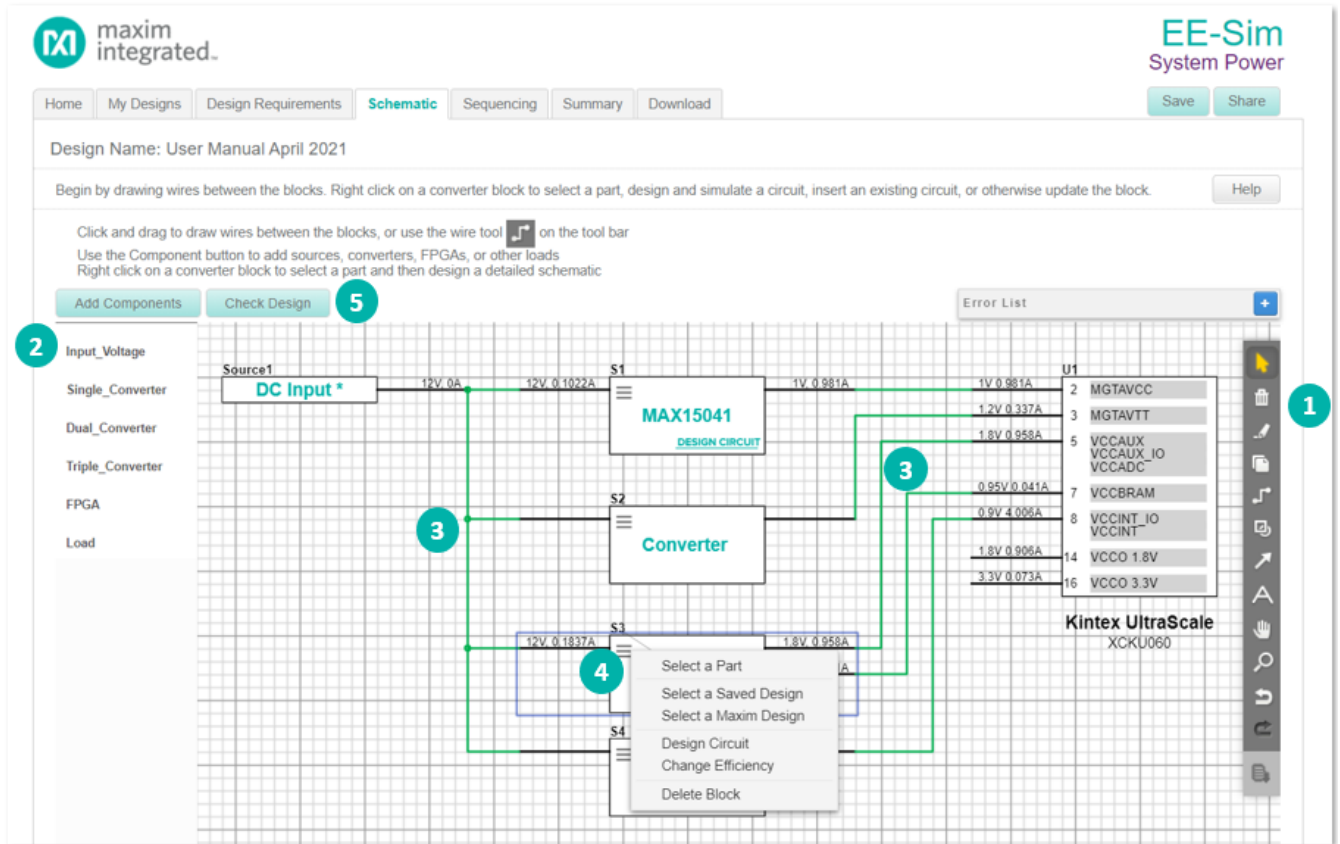

- 1 **Toolbar:** The right side of the window shows a toolbar including familiar commands such as print, undo, redo, zoom, select, delete, and wire commands. Position the mouse over an icon to view its functional name in a tooltip.
- 2 **Add Components:** Click this button to view the component menu. Choose a component. Move the mouse to position the new component in the grid.
- 3 **Connection Wires:** Position the mouse over a connection point; it changes to the X-shaped wire cursor. Connect a new line to another line or point. Red lines represent incomplete connections. Complete connections appear as straight-line segments or 90-degree connected line segments.
- 4 **Right-Click Menu:** To display a menu of component options, right-click the component or click on the hamburger menu in the upper-left corner.
- 5 **Check Design:** Click **Check Design** to determine if the converters are properly sized for the loads they are supporting. When navigating away from the **View Schematic** page, System Power automatically checks the design and reports any validation errors.

4.3.2 Select a Component

Select and change components directly in the schematic.

1. Open a system power design and click the **Schematic** tab.
2. Click on the hamburger menu, or right click a component. The resulting window varies for each type of component.
 - a. **DC Input:** Click on **Edit Source** to verify or change the **Input Voltage** fields, then click **OK**.
 - b. **Processor/FPGA:** In the **Edit FPGA** window, verify, change, or define the power requirements of each pin. Click **+ Add Row** to add a new row to the table. To learn more about creating a new processor in this design, refer to *4.1.1 Create a New FPGA Processor Design and Schematic*. When finished, click **OK**.

- c. **Load:** In the **Configure Load** window, complete the **Name**, **Required Voltage** (Volts), **Voltage Tolerance** (%), and **Required Current** (Amps) fields. Click **OK**.
- d. **Converter:**
 - i. Click **Select a Part** to open the **Solutions** window. Verify or change the **Converter Requirements**, apply one or more filters, then choose a converter. Click **Select Part** to use the highlighted part in your schematic. If the part is available in the EE-Sim DC-DC Converter Design tool, click the **Design It** button to add the converter to the schematic, and automatically design it. Refer to the following example.

The screenshot shows the EE-Sim Solutions window. At the top, it has the Maxim logo and 'EE-Sim' branding. The window is titled 'Solutions' and has a close button. Below the title bar, there are 'Converter Requirements' and 'Filter Options - Hide' sections. The 'Converter Requirements' section includes input fields for Nominal Vin (12 V), Minimum Vin (10.8 V), Maximum Vin (13.2 V), and a 'Reset' button. It also displays detected values: Vin 0.316, Pin 3.79, and Pout 3.03. There are four output configuration boxes: Output 1 (Vout: 1.8 V, Iout: 1.5 A), Output 2 (Vout: 3.3 V, Iout: 0.1 A), Output 3 (Vout: 1.8 V, Iout: 0.1 A), and Output 4 (Vout: 1.8 V, Iout: 0.1 A). The 'Filter Options - Hide' section has three columns: 'Converter Type' (Step Down Switcher, Step Up Down Switcher, Step Up Switcher, Inverting Regulator, LDO / Linear Switcher), 'Features' (Adjustable Freq., Avg. Current Mode Control, Current Limit, Dual / Multi - Phase, Fixed Freq./PWM, External Sync, Output OVP, Reset Output, Module), and 'More:' (Design Tool Available, Recommended, Synchronous Switching, Power Good Signal). Below the filters is the 'Choose Converter' section with a search bar and 'Select Part' and 'Cancel' buttons. A table lists various converters with columns for Partnumber, Num Out, Vin (V), Vout (V), Iout (A), Tol. (%), Freq. (kHz), Features, Recommended, Type, Tools, and Price. The table shows several 'Step Down Switcher' entries, with the third entry (MAX17232) selected. At the bottom, there are navigation arrows and a 'Showing 1 to 10 of 35' indicator.

- 1 **Converter Requirements:** Verify the detected voltage and current values are correct. Modify detected values, or manually add or delete rails. Click **Reset** to erase all custom values on the entire page and start over.
- 2 **Apply Filters:** Click Show Filters and check any desired filter criteria to narrow down the search results. Check **Design Tool Available** to find solutions that feature the EE-Sim DC-DC Converter Design tool. Click **Hide Filters** to stop showing the filter criteria and simplify the appearance of the page.
- 3 **Parameter Sort:** Click on an arrow to sort a column in increasing or decreasing order.
- 4 **Part Search:** Type a part number here to find a particular part.
- 5 **Select a Part:** Scroll or navigate to view all the matching solutions for your filter criteria. Position the mouse over the **Show link** in the **Features** column to view a summary of the key features for this device. The list includes features that match the filter criteria as well as any other features to help make an informed decision. Click on the check box, then click the **Select Part** button to use this device in the schematic.

6 **Display Options:** Click on the **Show More/Less** button to change paging and scrolling options. For example, choose **Show All** to view all results in one long scrolling list instead of page-by-page with 10 results per page. If too many solutions appear, apply specific input voltage, output current, and switching frequency filters at the top of the table, or filter on a part ID. If too few solutions appear, try relaxing the filter criteria

- ii. Click **Select a Saved Design** to choose one of your own saved designs and add it to your schematic by clicking the **Select** button on its left.
 - iii. Click **Select a Maxim Design** to choose one of Maxim's verified reference designs and add it to your schematic by clicking the **Select** button on its left.
 - iv. Click **Design Circuit** to pass your design parameters into the EE-Sim DC-DC Design Tool, and get an automatically designed circuit and BOM. (Simulations may be run as well.)
 - v. Click **Change Efficiency** to manually assign an efficiency value to this component (used to calculate your system power requirements.)
 - a. For any of the above types, the **Delete Block** option removes the block from the schematic.
3. Complete any additional tasks. For example, print, zoom, add wire, and check a design for errors.
4. Click **Save** in the upper left corner.

4.4 Sequencing

4.4.1 Add a Sequencer

Typically, a design should include at least one sequencer to manage the flow of power to the rails in the prescribed order.

1. Open a system power design and click the **Sequencing** tab.
2. Click the **Add Sequencer** button.
3. In the **Find a Solution** window:
 - a. Click **Show Filters** (it may already be displayed).
 - b. In the **Input Channels** section, enter values for the Min and Max number of input channels.
 - c. In the **Voltage Input** section, enter a value for the Max voltage.
 - d. In the **Interface**, **Option**, and **Features** sections, check the desired filter criteria to narrow the search results.
 - e. In the **Choose Sequencer** section, scroll or navigate to the pages that show matching parts. Click a column heading to sort or enter a search phrase to find specific matching sequencers.
4. Select a sequencer in the list, then click **Select Part**.
5. On the **Sequencing** page in the **Sequencer Selection** section:
 - a. Verify the selected sequencer appears and the number of input channels is acceptable.
 - b. To change parts, click **Edit**.
 - c. To delete this sequencer, click **Delete**.
 - d. To add another sequencer, click **Add Sequencer** and repeat the steps in this procedure.
 - e. To verify the timings using a timing diagram, check the box for **Check for Timing View**.
6. Click **Save**.

4.4.2 Edit the Group/Rail Assignments and View the Timing Diagrams

Perform these steps to edit the group/rail assignments and generate timing diagrams.

1. Open a system power design and click the **Sequencing** tab.
2. Verify that at least one sequencer has been added.
3. Expand the **Group/Rail Assignment** section. The color-coded FPGA Groups and Rail(s) data appear only when at least one sequencer has been added.
4. For each FPGA Group and rail or pin:
 - a. Choose a sequencer reference designation from the **Sequencer** field.
 - b. Enter a **Delay On** value in milliseconds. This is the delay from t=0 seconds before power is applied to the rail.
 - c. Enter a **Delay Off** value in milliseconds. This is the delay from t=0 seconds before power is terminated to the rail.
5. Click **Apply Changes**.
6. Expand the **Timing Diagram** section and examine the **Delay On** and **Delay Off** graphs.
7. (Optional) Position the mouse over a data point in the graph to view its FPGA group, voltage out, and delay in milliseconds.
8. Click **Save**.

4.5 Generate a Summary Page and BOM (System Power)

4.5.1 Explore the System Power Tool Summary Page

1. Open a system power design and click the **Summary** tab.
2. Click **Part Links** to expand this section and view the following data:
 - a. **Ref Des:** The abbreviated name or ID for the part as it is referenced in the design schematic. For example, item PS1 represents a power supply and item U1 represents a processor/FPGA.
 - b. **Part Number:** The OEM part number, model name, or generic item name such as *Power Supply*.
 - c. **Device Type:** The category for the part, such as *Processor/FPGA*, *Sequencer*, or *Supply*.
 - d. Click **Data Sheet** to view a multi-page PDF document with complete part specifications, commands, and other reference information.
 - e. Click **Info** to view additional online information about the part.
3. Click Design Requirements to expand this section and view the Input Voltage requirements and the Processor/FPGA requirements from the original **Design Requirements** page including the manufacturer, model or family, device number, pin names, pin groups, voltages, amperes, and supply tolerances.
4. Click **Top Level Schematic** to expand this section and view the diagram in read-only mode.
5. Click **Converters** to view the Design Requirements for each converter used in the schematic. If the converter was designed and simulated in the EE-Sim DC-DC Converter Design tool, those results are shown here (BOM, schematic, waveforms, etc.)
6. Click **Sequencing** to expand this section and reveal three subsections:
 - a. Click **Sequencer Selection** to view any sequencers chosen.
 - b. Click **Group/Rail Assignment** to view these assignments.
 - c. Click **Timing Diagram** to view the timing diagrams for this device.
 - d. To make any changes, click the **Sequencing** tab.
7. Click **Save** in the upper left corner to save the final version of the design.

4.5.2 Generate and Print a Summary Page

View a web page or PDF that summarizes the design in the following five sections:

- Part Links
 - Design Requirements
 - Top Level Schematic
 - Converters
 - Sequencing
1. Open a system power design.
 2. For a summary page in HTML format:
 - a. Click the **Summary** tab.
 - b. The **Summary** page appears showing all five sections in the web browser.
 3. For a summary page in PDF format:
 - c. Click the **Download Designs** tab.
 - d. Click **Summary PDF** to view, open, or save the **Summary** page with all five sections in a PDF file.
 4. From the web browser or the PDF file, click **Print** to print the summary to a printer, network copier, fax device, or to save the file as a PDF, XPS, or other format.

4.5.3 Generate and Save a BOM

Use this procedure to generate, view, and save a bill of materials (BOM) for a system power design.

1. Open a system power design and click the **Download Designs** tab.
2. Click **Excel BOM**.
3. Open or save the BOM as an Excel spreadsheet file with the following columns:
 - Reference ID (matching the item identifiers used in the schematic)
 - Quantity
 - Part Number
 - Manufacturer
 - Description

5 EE-Sim OASIS Simulator

The EE-Sim OASIS Simulator is available as a complementary download for EE-Sim tool users. Perform any of the following tasks:

- Simulate your circuit.
- Perform enhanced schematic editing, waveform viewing, and analysis.
- Run the SIMPLIS simulation engine for switching power supply applications.
- Run the SIMetrix SPICE simulation engine.

5.1 Download EE-Sim OASIS Simulator

Download EE-Sim OASIS Simulator for offline use on a PC running Microsoft Windows 10 **64-bit edition** (Home, Pro or Enterprise).

NOTE: EE-Sim OASIS software does not install or run on Windows 95, 98, or ME.

1. Navigate to www.maximintegrated.com and start the online edition of the EE-Sim Design and Simulation Environment. (See the first chapter of this guide if you need assistance.)
2. Click the **Download** tab.
3. Click the **EE-Sim-OASIS-Installer** button.
4. Save the installation file to your desktop or temporary downloads folder.
5. Exit all other applications.
6. Continue to the next procedure to run the installer.

NOTE: After installing EE-Sim OASIS Simulator, you can safely delete the installation file.

5.2 Install EE-Sim OASIS Simulator

The installer follows the same application standards that apply to all Windows software programs.

1. Open the installer application. For example, click **ee-sim-oasis-installer-xx.exe**.
2. If the **User Account Control** window appears, click **Yes**. The software has a valid security certificate.

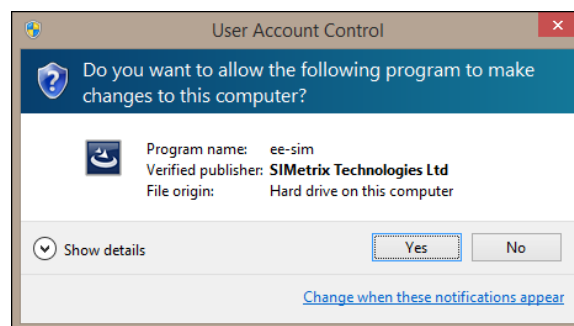

3. The installation wizard appears to guide you through a series of installation options spanning multiple pages. Click **Next**.

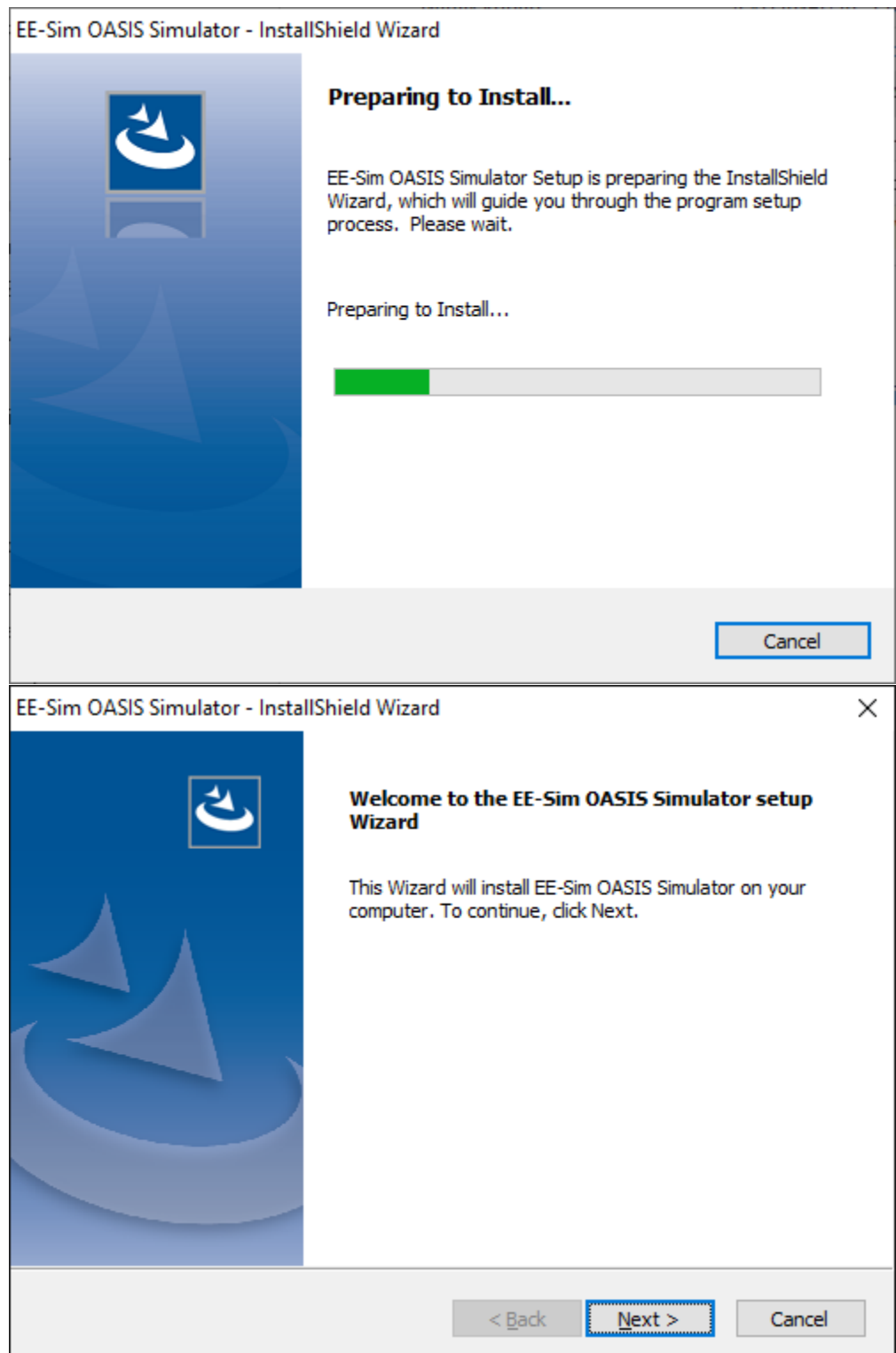

4. In the **License Agreement** window, scroll down to read the terms and click **I accept the terms of the license agreement**. Click **Print** to save a copy of the terms. To continue, click **Next**.

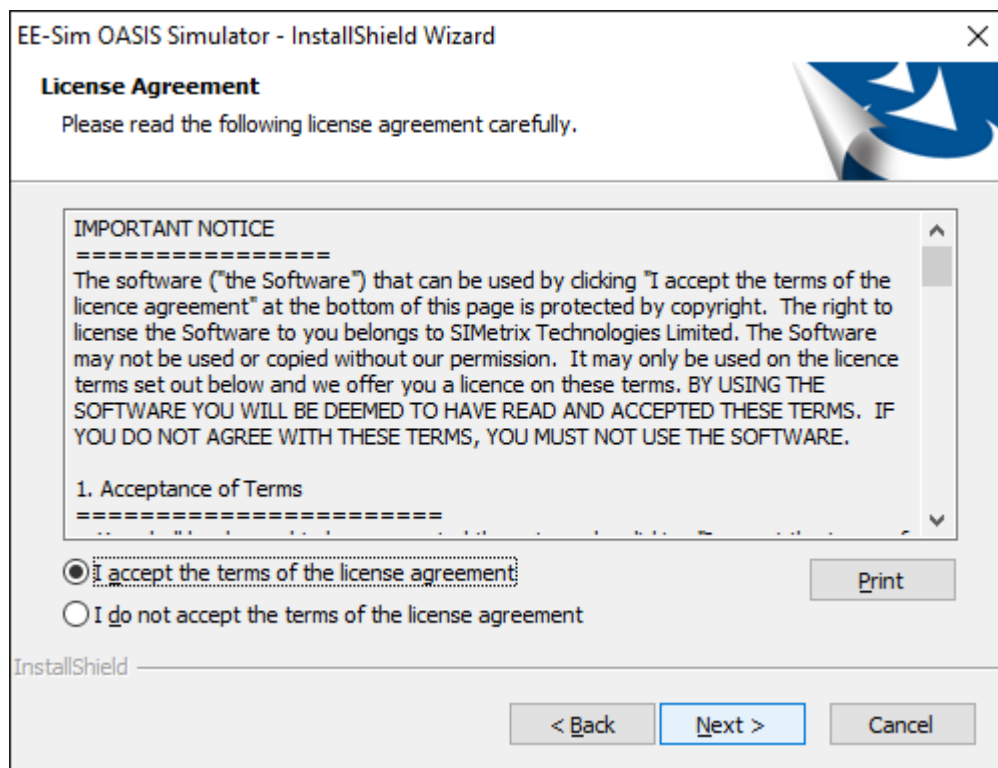

5. In the **Choose Destination Location** window, if you accept the default folder destination, click **Next** to continue. To specify a different directory, click **Browse**, navigate to another folder, and select it. Then, click **Next**.

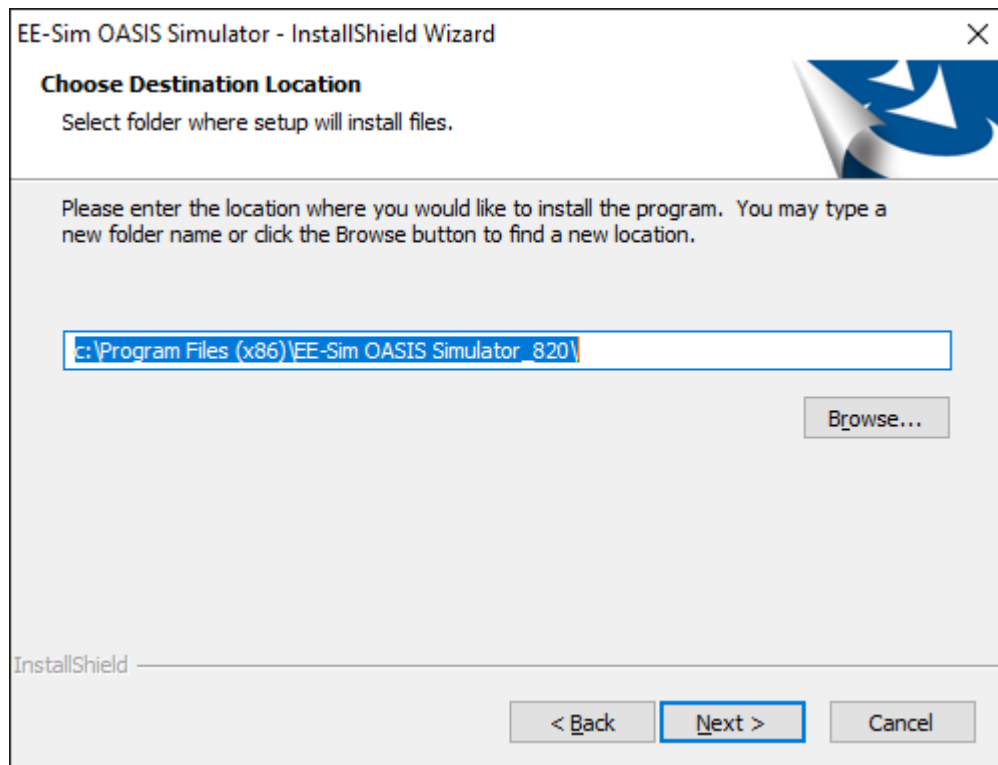

6. In the **Ready to Install the Program** window, click **Install**.

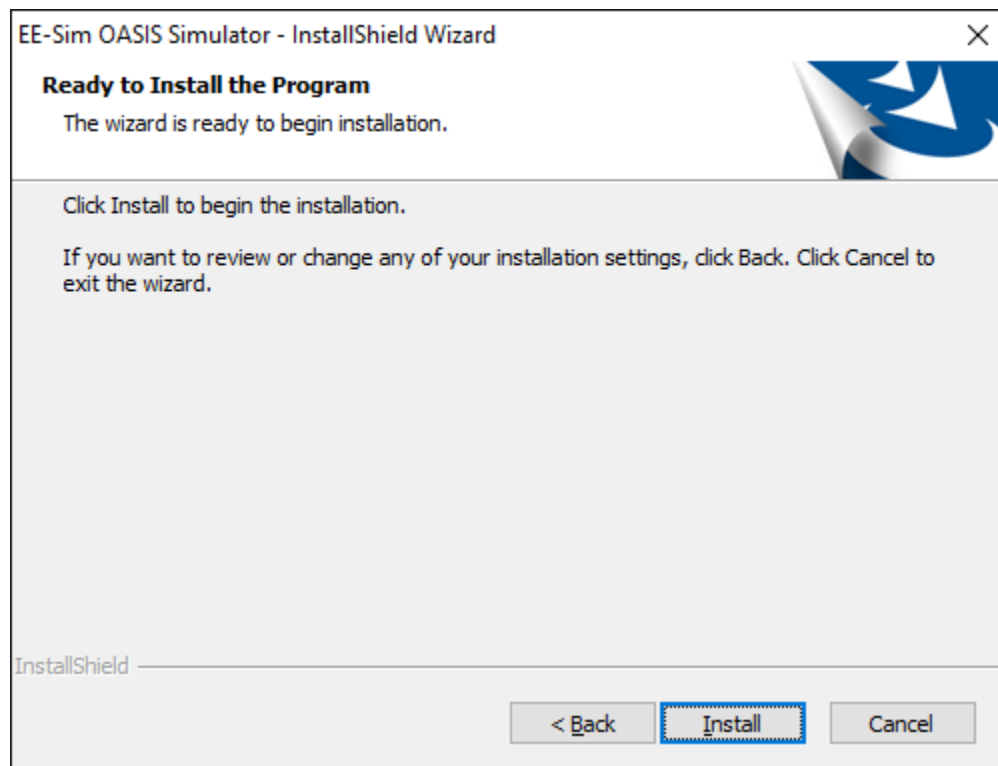

7. A window appears to notify you that the installation is complete. Click **Finish**.

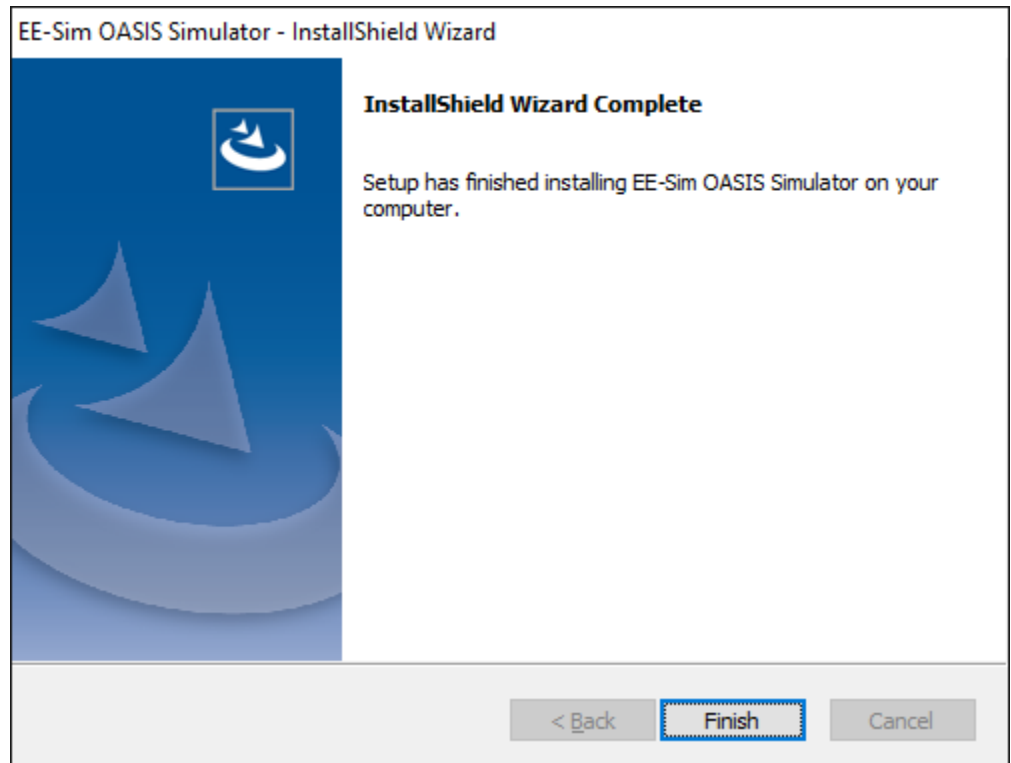

5.3 Start Using the EE-Sim OASIS Simulator for Windows

Follow these steps after the installation to open the offline application and get started.

1. From your Windows desktop, click **Start**, then click **EE-Sim**, or type “**ee-sim**” into the search field.

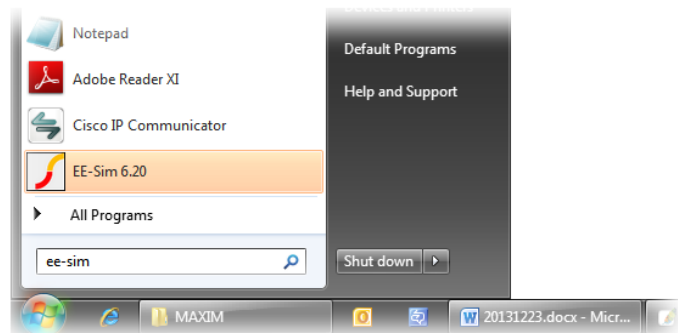

Windows 10 or 8.1 users can start EE-Sim by tapping or clicking its Start tile located with their other applications:



NOTE: Windows 10 or 8.1 users can customize their EE-Sim tile or can create desktop shortcuts including a Quick Launch toolbar just like previous versions of Windows.

2. In the **Starting EE-Sim for the First Time** message box, select the following options:
 - a. **Preferences from Earlier Version:** This option only applies if you had a previous version of OASIS installed on your PC. Click **Yes** to migrate your old configuration settings, or click **No** to start over with new settings copied from the installer.
 - b. **Example Files:** Click **Yes** to install example files including schematics and instructional materials or click **No** to skip this optional content.

c.

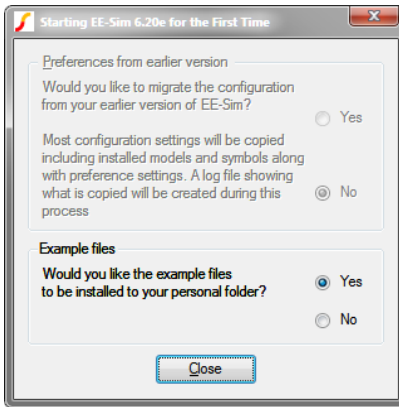

If you click **Yes** for the example files, they appear in your **My Documents** folder in a series of sub-folders as shown below:

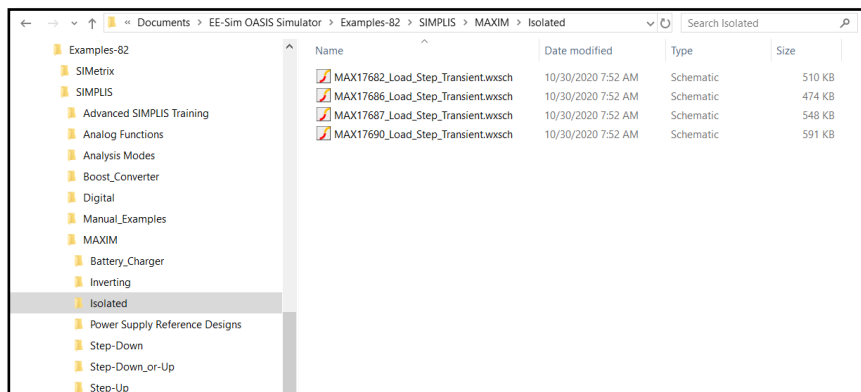

d. After selecting **Yes** or **No**, click **Close**.

- At the EE-Sim OASIS startup window, click **OK**.

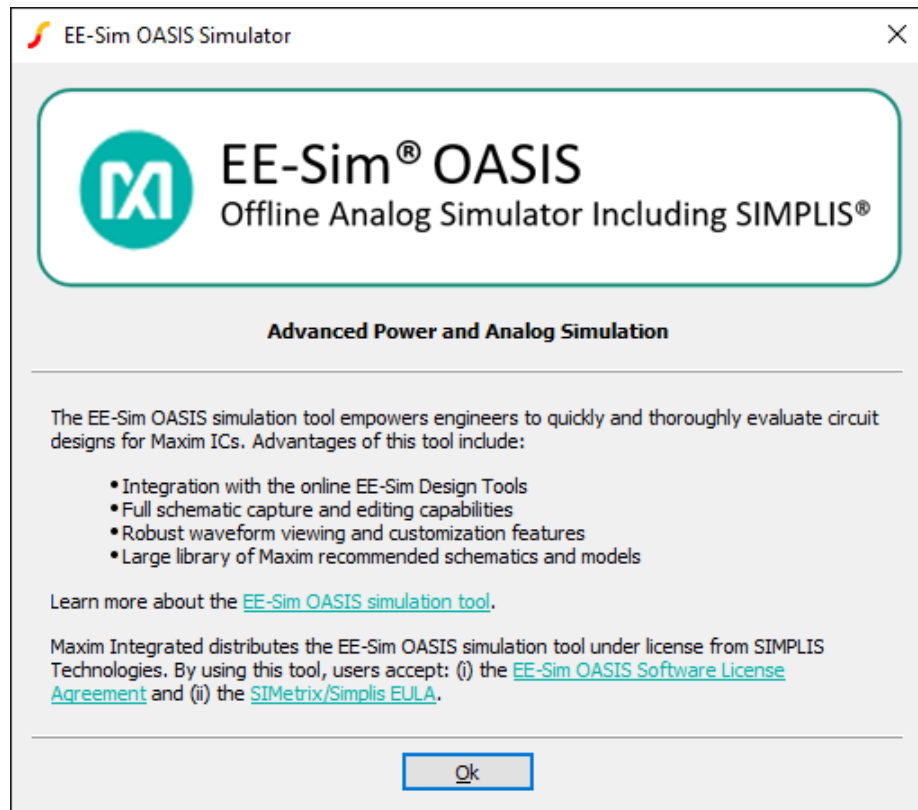

- To open a schematic from the small command shell window, choose **Open Schematic** from the **File** menu. To open a schematic from the editor window, choose **Open** from the **File** menu. EE-Sim OASIS schematic files end in either of the following extensions:
 - sxsch
 - wxsch
- Click **Help** in the command shell window to open detailed help files.

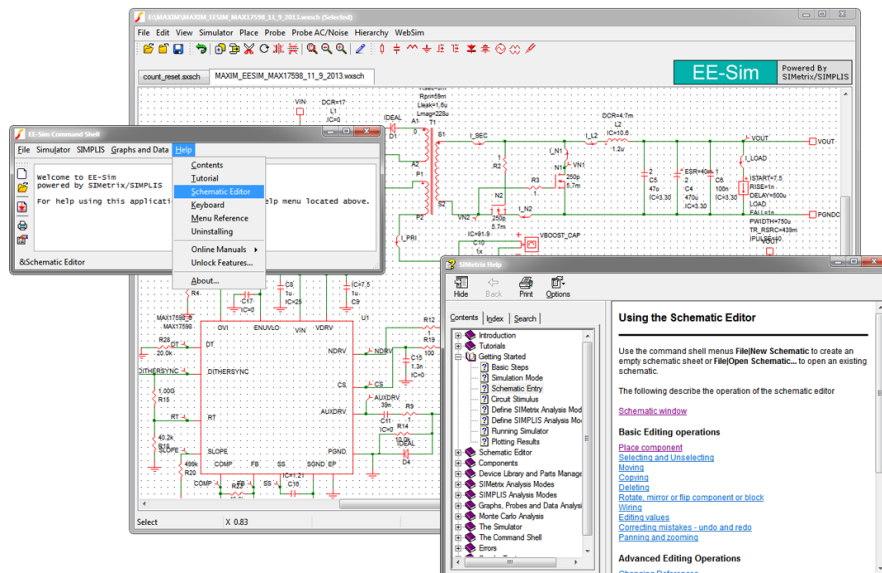

5.4 Download a Schematic

In the DC-DC Converter tool, download a schematic and edit it in EE-Sim OASIS Simulator.

1. Navigate to www.maximintegrated.com and start the online edition of the EE-Sim Design and Simulation Environment.
2. Create or open a design (see Chapter 3 for assistance).
3. Click the **Download** tab.
4. Under the **Download your Current Design Files** heading, click the **Schematic** link.
5. For DC-DC converter designs, in the **Choose Analysis** pop-up window, select one of the following values:
 - **Steady State**
 - **AC Loop**
 - **Load Step**
 - **Start Up**
 - **Line Transient**

NOTE: The load, voltage source (VIN), and simulation settings in the downloaded schematic are configured based on which analysis type you select. The same schematic downloads for each of these simulation types. The only difference is that the load, input voltage source VIN, and simulator setting are preset to match those used online for this simulation type. This makes it much easier to get started simulating in EE-Sim OASIS. To run a different analysis in EE-Sim OASIS, return to the online tool and select a different analysis type, or manually configure the simulation in EE-Sim OASIS.

6. Click **Download**.
7. For help using EE-Sim OASIS Simulator, open the EE-Sim Command Shell and visit the resources available under the **Help** menu.
8. If you save the schematic zip file for several types of analysis, note the file names indicate the analysis type. For example: MAX15066_SS.wxsch, MAX15066_AC.wxsch, MAX15066_LS.wxsch, MAX15066_SU.wxsch, and MAX15066_LTR.wxsch.
9. To edit the .wxsch schematic file, open the zip archive file, then drag the schematic file to a folder where you can view and edit your schematic files in the EE-Sim OASIS application for Windows. Or, right-click the .zip file and choose **Extract All** to select a folder.
10. Close the **Choose Analysis** window.

Refer to the following graphic for download examples in Google Chrome and Internet Explorer.

The screenshot shows the EE-Sim DC-DC web interface. At the top left is the Maxim Integrated logo. The top right shows 'EE-Sim DC-DC' and 'Save' and 'Share' buttons. A navigation bar includes 'Home', 'My Designs', 'Design Requirements', 'Schematic', 'Compare', 'Report', and 'Download' (highlighted with a red circle 1). Below the navigation bar, the 'Part Number' is MAX20008 and the 'Design Name' is MAX20008 with Pulse L1 and note. A 'Help' button is on the right. The main content area is divided into two columns. The left column is titled 'Download EE-Sim OASIS Simulator' and contains information about the simulator version (8.2R, 182MB) and a download link for 'EE-Sim-OASIS-Installer.exe' (highlighted with a red circle 2). It also lists reasons for downloading the simulator and provides installation and update instructions. The right column is titled 'Download your Current Design Files' and offers options for 'Bill of Materials (BOM)', 'Summary Report', and 'Schematic' (highlighted with a red circle 3). A 'BOM Export Summary PDF Schematic' link is also present. A modal dialog box titled 'Choose analysis' (highlighted with a red circle 4) is open in the center, allowing the user to select a simulation configuration: Steady State, AC Loop, Load Step, Start Up, or Line Transient (which is selected). An alert at the bottom of the dialog states: 'Alert: Use version 8.2L or higher of EE-Sim OASIS to ensure compatibility.' The dialog has a 'Download' button and a close 'X' button. The footer contains copyright information for 2021 Maxim Integrated and a 'POWERED BY TRANSIM' logo.

- 1 **Download Designs:** Click this tab when you are ready to download your schematic. You can also download the offline application on this page.
- 2 **EE-Sim Offline Simulator:** Download and install the EE-Sim OASIS executable application to continue your design work and run additional simulations from your Windows PC.
- 3 **Current Schematic:** Download your design data and schematic diagram as a .wxsch file for offline editing. Click **Schematic**. The bill of materials (BOM) and summary report are also available for download.
- 4 **Choose Analysis:** Select the type of simulation test data to export with your schematic using this window. After you click **Download**, this window continues to appear and allows you to make another selection and download another schematic. Or, click the **X** to close the window.

6 Design Gallery

The EE-Sim Design Gallery provides an opportunity for all EE-Sim users to share their designs. Any DC-DC design that has been created and saved in the EE-Sim Tool can be posted to the Design Gallery. Once posted in the Design Gallery, any EE-Sim user can view critical information about the design, including:

- Design Title
- Schematic Image
- Description
- Design Requirements
- Bill of Materials
- Simulation Waveforms (if simulations were run)
- SIMPLIS Schematics to Download (.wxsch files)
- Designer Name
- Date Posted

Note that once posted, the design cannot be changed or accessed by the EE-Sim community. It is shared in a “read-only” manner.

In addition to being visible to the EE-Sim community, a posted design can also be shared on supported social media platforms. The supported social media platforms include:

- Facebook
- LinkedIn
- Twitter
- WeChat

In all cases, the social media post may be customized by the poster, and it will include a link to the design in the Design Gallery. Some social media platforms also include the Description text and the Schematic Image.

A best practice is to write a specific and complete Description so that other users will understand what the target application is, how particular challenges were overcome, and any important benefits of the posted design.

7 Trademarks

EE-Sim is a registered trademark of Maxim Integrated Products, Inc.

Excel is a registered trademark of Microsoft Corporation.

Firefox is a registered trademark of Mozilla Foundation Corporation.

Gmail is a registered service mark of Google Inc.

Google Chrome is a registered trademark and registered service mark of Google Inc.

Internet Explorer is a registered trademark of Microsoft Corporation.

macOS is a registered trademark of Apple Inc.

SIMPLIS is a registered trademark of SIMPLIS Technologies, Inc.

Windows, Windows Vista, and Windows XP are registered trademarks and registered service marks of Microsoft Corporation.

8 Revision History

REV NUMBER	REV DATE	DESCRIPTION	PAGES CHANGED
0	6/16	Initial release	—
1	4/17	Updated screenshot images in <i>Section 5: System Power</i>	48, 49
2	8/17	Removed references to V2 (renamed from V1 and V2 to DC-DC) and removed <i>Section 4: DC-DC Converter Designs V1</i>	13, 25, 26, 28, 29, 38–44
3	6/21	Major update to reflect upgrades to user interface and navigation, new OASIS Simulator, and Design Gallery	1–58



Information furnished by Analog Devices is believed to be accurate and reliable. However, no responsibility is assumed by Analog Devices for its use, nor for any infringements of patents or other rights of third parties that may result from its use. Specifications subject to change without notice. No license is granted by implication or otherwise under any patent or patent rights of Analog Devices. Trademarks and registered trademarks are the property of their respective owners.